



**BMS INSTITUTE OF TECHNOLOGY AND MANAGEMENT  
YELAHANKA BANGALORE-560064  
DEPARTMENT OF CIVIL ENGINEERING**

# **Municipal and Industrial Waste Water Engineering**

**17CV71**



**BMS INSTITUTE OF TECHNOLOGY AND MANAGEMENT  
YELAHANKA BANGALORE-560064  
DEPARTMENT OF CIVIL ENGINEERING**

**Module – 1  
Introduction**

**Structure**

- 1.0 Introduction
- 1.1 Objectives
- 1.2 Methods of sewage disposal
- 1.3 Types of sewerage systems
- 1.4 Quantity of storm water flow
- 1.5 Materials of sewers
- 1.6 Shape of sewers,
- 1.7 Laying and testing of sewers
- 1.8 Low-cost waste treatment
- 1.9 Sewer appurtenances
- 1.10 Recommended questions
- 1.11 Outcomes
- 1.12 Further Reading



**BMS INSTITUTE OF TECHNOLOGY AND MANAGEMENT**  
**YELAHANKA BANGALORE-560064**  
**DEPARTMENT OF CIVIL ENGINEERING**

## **1.0 Introduction:**

### **Necessity for sanitation**

Every community produces both liquid and solid wastes. The liquid portion –waste water– is essentially the water supply of the community after it has been fouled by a variety of uses such as spent water from bathroom, kitchen, lavatory basins, house and street washings, from various industrial processes semi solid wastes of human and animal excreta, dry refuse of house and street sweepings, broken furniture, wastes from industries etc are produced daily.

If proper arrangements for the collection, treatment and disposal are not made, they will go on accumulating and create foul condition. If untreated water is accumulating, the decomposition of the organic materials it contains can lead to the production of large quantity of mal odorous gases. It also contains nutrients, which can stimulate the growth of aquatic plants and it may contain toxic compounds. Therefore in the interest of community of the city or town, it is most essential to collect, treat and dispose of all the waste products of the city in such a way that it may not cause any hazardous effects on people residing in town and environment.

Waste water engineering is defined as the branch of the environmental engineering where the basic principles of the science and engineering for the problems of the water pollution problems. The ultimate goal of the waste water management is the protection of the environmental in manner commensurate with the economic, social and political concerns.

Although the collection of stream water and drainage dates from ancient times the collection of waste water can be treated only to the early 1800s. The systematic treatment of waste water followed in the 1800s and 1900s.

### **Importance of sewerage system**

One of the fundamental principles of sanitation of the community is to remove all decomposable matter, solid waste, liquid or gaseous away from the premises of dwellings as fast as possible after it is produced, to a safe place, without causing any nuisance and dispose it in a suitable manner so as to make it permanently harmless.

Sanitation though motivated primarily for meeting the ends of preventive health has come to be recognized as a way of life. In this context, development of the sanitation infrastructure of any country could possibly serve as a sensitive index of its level of prosperity. It is needless to emphasize that for attaining the goals of good sanitation, sewerage system is very essential. While provision of potable drinking water takes precedence in the order of provision of

Environmental Engineering Services, the importance of sewerage system cannot be last sight and cannot be allowed to lag behind, as all the water used by the community has to flow back as the sewage loaded with the wastes of community living, unless properly collected, treated and disposed off, this would create a serious water pollution problems.



**BMS INSTITUTE OF TECHNOLOGY AND MANAGEMENT  
YELAHANKA BANGALORE-560064  
DEPARTMENT OF CIVIL ENGINEERING**

**Definitions of some common terms used in the sanitary engineering.**

**Refuse:** This is the most general term to indicate the wastes which include all the rejects left as worthless, sewage, sullage – all these terms are included in this term.

**Garbage:** It is a dry refuse which includes, waste papers, sweepings from streets and markets, vegetable peelings etc. The quantity of garbage per head per day amounts to be about .14 to .24 kg for Indian conditions. Garbage contains large amount of organic and putrifying matter and therefore should be removed as quickly as possible.

**Rubbish:** It consists of sundry solid wastes from the residencies, offices and other buildings. Broken furniture, paper, rags etc are included in this term. It is generally dry and combustible.

**Sullage:** It is the discharge from the bath rooms, kitchens, wash basins etc., it does not include discharge from the lavatories, hospitals, operation theaters, slaughter houses which has a high organic matter.

**Sewage:** It is a dilute mixture of the wastes of various types from the residential, public and industrial places. It includes sullage water and foul discharge from the water closets, urinals, hospitals, stables, etc.

**Storm Water:** It is the surface runoff obtained during and after the rainfall which enters sewers through inlet. Storm water is not foul as sewage and hence it can be carried in the open drains and can be disposed off in the natural rivers without any difficulty.

**Sanitary Sewage:** It is the sewage obtained from the residential buildings & industrial effluents establishments. Being extremely foul it should be carried through underground conduits.

**Domestic Sewage:** It is the sewage obtained from the lavatory basins, urinals & water closets of houses, offices & institutions. It is highly foul on account of night soil and urine contained in it. Night soil starts putrefying & gives offensive smell. It may contain large amount of



**BMS INSTITUTE OF TECHNOLOGY AND MANAGEMENT**  
**YELAHANKA BANGALORE-560064**  
**DEPARTMENT OF CIVIL ENGINEERING**

bacteria due to the excremental wastes of patients. This sewage requires great handling & disposal.

**Industrial Sewage:** It consists of spent water from industries and commercial areas. The degree of foulness depends on the nature of the industry concerned and processes involved.

**Sewers:** Sewers are underground pipes which carry the sewage to a point of disposal.

**Sewerage:** The entire system of collecting, carrying & disposal of sewage through sewers is known as sewerage.

**Bacteria:** These are the microscopic organisms. The following are the groups of bacteria:

- Aerobic bacteria: they require oxygen & light for their survival.
- Anaerobic bacteria: they do not require free oxygen and light for survival.
- Facultative bacteria: they can exist in the presence or absence of oxygen. They grow more in absence of air.

**Invert:** It is the lowest point of the interior of the sewer at any c/s.

**Sludge:** It is the organic matter deposited in the sedimentation tank during treatment.

### 1.1 Methods of domestic waste water (Sewage) disposal

After the waste water is treated it is disposed in the nature in the following two principal methods

- a. Disposal by Dilution where large receiving water bodies area available
- b. Land disposal where sufficient land is available

The choice of method of disposal depends on many factors and is discussed later. Sanitary Engineering starts at the point where water supply Engineering ends.

It can be classified as

- Collection works
- Treatment works
- Disposal works

The collection consists of collecting all types of waste products of town. Refuse is collected separately. The collection works should be such that waste matters can be transported quickly and steadily to the treatment works. The system employed should be self cleaning and economical.

Treatment is required to treat the sewage before disposal so that it may not pollute the atmosphere & the water body in which it will be disposed of. The type of treatment processes depend on the nature of the waste water characteristics and hygiene, aesthetics and economical aspects.

The treated water is disposed of in various ways by irrigating fields or discharging in to natural water courses.

Different Methods of domestic waste water disposal include (Systems of Sanitation)



**BMS INSTITUTE OF TECHNOLOGY AND MANAGEMENT**  
**YELAHANKA BANGALORE-560064**  
**DEPARTMENT OF CIVIL ENGINEERING**

1. Old Conservancy System
2. Modern Water Carriage System

### Old Conservancy System

Sometimes the system is also called as dry system. This is out of date system but is prevailing in small towns and villages. Various types of refuse and storm water are collected conveyed and disposed of separately. Garbage is collected in dustbins placed along the roads from where it is conveyed by trucks ones or twice a day to the point of disposal. All the non combustible portion of garbage such as sand dust clay etc are used for filling the low level areas to reclaim land for the future development of the town. The combustible portion of the garbage is burnt. The decaying matters are dried and disposed of by burning or the manufacture of manure.

Human excreta are collected separately in conservancy latrines. The liquid and semi liquid wastes are collected separately after removal of night soil it is taken outside the town in trucks and buried in trenches. After 2-3 years the buried night soil is converted into excellent manure. In conservancy system sullage and storm water are carried separately in closed drains to the point of disposal where they are allowed to mix with river water without treatment.

### Modern Water Carriage System

With development and advancement of the cities urgent need was felt to replace conservancy system with some more improved type of system in which human agency should not be used for the collection and conveyance of sewage. After large number of experiments it was found that the water is the only cheapest substance which can be easily used for the collection and conveyance of sewage. As in this system water is the main substance therefore it is called as Modern Water Carriage System.

In this system the excremental matter is mixed up in large quantity of water their are taken out from the city through properly designed sewerage systems, where they are disposed of after necessary treatment in a satisfactory manner.

The sewage so formed in water carriage system consist of 99.9% of water and 0.1% solids. All these solids remain in suspension and do not changes the specific gravity of water therefore all the hydraulic formulae can be directly used in the design of sewerage system and treatment plants.

<b>Conservancy System</b>	<b>Water Carriage System</b>
Very cheap in initial cost.	It involves high initial cost.
Due to foul smells from the latrines, they are to be constructed away from living room so building cannot be constructed as compact units.	As there is no foul smell latrines remain clean and neat and hence are constructed with rooms, therefore buildings may be compact.
The aesthetic appearance of the city cannot be improved.	Good aesthetic appearance of city can be obtained.
For burial of excremental matter large area is required.	Less area is required as compared to conservancy system.



**BMS INSTITUTE OF TECHNOLOGY AND MANAGEMENT**  
**YELAHANKA BANGALORE-560064**  
**DEPARTMENT OF CIVIL ENGINEERING**

Excreta are not removed immediately hence its decomposition starts before removal, causing nuisance smell.	Excreta are removed immediately with water, no problem of foul smell or hygienic trouble.
This system is fully depended on human agency .In case of strike by the sweepers; there is danger of insanitary conditions in city.	As no human agency is involved in this system ,there is no such problem as in case of conservancy system

### 1.2 Types of Sewerage Systems:

1. Separate System of Sewage
2. Combined System of Sewage
3. Partially Combined or Partially Separate System

**Separate System of Sewerage:** In this system two sets of sewers are laid .The sanitary sewage is carried through sanitary sewers while the storm sewage is carried through storm sewers. The sewage is carried to the treatment plant and storm water is disposed of to the river.

#### Advantages:

- Size of the sewers are small
- Sewage load on treatment unit is less
- Rivers are not polluted
- Storm water can be discharged to rivers without treatment.

#### Disadvantage:

- Sewerage being small, difficulty in cleaning them
- Frequent choking problem will be their
- System proves costly as it involves two sets of sewers
- The use of storm sewer is only partial because in dry season the will be converted in to dumping places and may get clogged.

**Combined System of Sewage:** When only one set of sewers are used to carry both sanitary sewage and surface water. This system is called combined system.

Sewage and storm water both are carried to the treatment plant through combined sewers

#### Advantages:

- Size of the sewers being large, choking problems are less and easy to clean.
- It proves economical as 1 set of sewers are laid.
- Because of dilution of sanitary sewage with storm water nuisance potential is reduced

#### Disadvantages:

- Size of the sewers being large, difficulty in handling and transportation.
- Load on treatment plant is unnecessarily increased
- It is uneconomical if pumping is needed because of large amount of combined flow.
- Unnecessarily storm water is polluted.



**BMS INSTITUTE OF TECHNOLOGY AND MANAGEMENT**  
**YELAHANKA BANGALORE-560064**  
**DEPARTMENT OF CIVIL ENGINEERING**

**Partially Combined or Partially Separate System:** A portion of storm water during rain is allowed to enter sanitary sewer to treatment plants while the remaining storm water is carried through open drains to the point of disposal.

**Advantages:**

- The sizes of sewers are not very large as some portion of storm water is carried through open drains.
- Combines the advantages of both the previous systems.
- Silting problem is completely eliminated.

**Disadvantages:**

- During dry weather, the velocity of flow may be low.
- The storm water is unnecessary put load on to the treatment plants to extend.
- Pumping of storm water in unnecessary over-load on the pumps.

Suitable conditions for separate sewerage systems:-

A separate system would be suitable for use under the following situations:

- Where rainfall is uneven.
- Where sanitary sewage is to be pumped.
- The drainage area is steep, allowing to runoff quickly.
- Sewers are to be constructed in rocky strata. The large combined sewers would be more expensive.

Suitable conditions for combined system:-

- Rainfall in even throughout the year.
- Both the sanitary sewage and the storm water have to be pumped.
- The area to be sewerred is heavily built up and space for laying two sets of pipes is not enough.
- Effective or quicker flows have to be provided.

After studying the advantages and disadvantages of both the systems, present day construction of sewers is largely confined to the separate systems except in those cities where combined system already exists. In places where rainfall is confined to one season of the year, like India and even in temperate regions, separate system are most suitable.

<b>Separate system</b>	<b>Combined system</b>
The quantity of sewage to be treated is less, because no treatment of storm water is done.	As the treatments of both are done, the treatment is costly.
In the cities of more rainfall this system is more suitable.	In the cities of less rainfall this system is suitable.
As two sets of sewer lines are to laid, this system is cheaper because sewage is carried in underground sewers and storm water in open drains.	Overall construction cost is higher than separate system.





**BMS INSTITUTE OF TECHNOLOGY AND MANAGEMENT**  
**YELAHANKA BANGALORE-560064**  
**DEPARTMENT OF CIVIL ENGINEERING**

In narrow streets, it is difficult to use this system.	It is more suitable in narrow streets.
Less degree of sanitation is achieved in this system, as storm water is disposed without any treatment.	High degree of sanitation is achieved in this system.

**Dry Weather Flow (DWF):** Domestic sewage and industrial sewage collectively called as DWF. It does not contain storm water. It indicates the normal flow during dry season of the year.

**Wet Weather Flow (WWF):** Domestic sewage, industrial sewage and storm water collectively called as WWF. It indicates the maximum flow of sewage during wet season.

**Factors Affecting DWF:**

The dry weather flow or the quantity of sanitary sewage depends upon the following factors:-

- Rate of water supply
- Population growth
- Type of area served
- Infiltration of ground water

**Rate of Water Supply:** The rate of water supply to a city or town is expressed so many litres/capita/day. The quantity of waste water entering the sewers would be less than the total quantity of water supplied. This is because of the fact that water is lost in domestic consumption, evaporation, lawn sprinkling, fire fighting, industrial consumption. However, private source of water supply (i.e. water from domestic wells etc.) and infiltration of sub-soil water in the sewers increase the waste water flow rate.

This extra water that enters the sewers can be assumed to approximately equal to the water lost in consumption etc. Due to this reason, the waste water flow rate may be assumed equal to the rate of water supply by the municipal authorities. The sewers should be designed for a minimum of 150 litres per capita per day.

**Population Growth:** The quantity of sanitary sewage directly depends on the population. As the population increases the quantity of sanitary sewage also increases. The quantity of water supply is equal to the rate of supply multiplied of population. The sewage quantity which will be produced in the town due to future developments of the town and population should be taken into account and as far as possible accurate results should be obtained.

**Type of Area Served:** The quantity of sanitary sewage also depends on the type of area to be served, whether it is residential, industrial or commercial. The quantity of sewage produced in residential areas directly depends on the quantity of water supply to the area. The quantity is obtained by multiplying the population with this factor. The quantity of sewage produced by various industries depends on their various industrial, processes, and it is different for each industry. This quantity can be determined by doing a survey of that area and collecting the data.



**BMS INSTITUTE OF TECHNOLOGY AND MANAGEMENT**  
**YELAHANKA BANGALORE-560064**  
**DEPARTMENT OF CIVIL ENGINEERING**

**Infiltration of Ground Water:** Ground water or sub-soil water may infiltrate into the sewers through the leaky joints. Ex-filtration is the reverse process which indicated the flow of waste water from the sewer into the ground. While due to infiltration the quantity of flow through sewer increases, ex-filtration results in decrease in the flow and consequent increase in the pollution of ground water. Both infiltration as well as ex-filtration are undesirable and take place due to imperfect joints. Infiltration unnecessarily increases the load on the treatment works.

### 1.3 Quantity of storm water flow:

When rain falls over the ground surface, a part of it percolates into the ground, a part is evaporated in the atmosphere and the remaining part overflows as storm water. This quantity of storm water is very large as compared with sanitary sewage.

Factors affecting storm water:-

The following are factors which affect the quantity of storm water:

1. Rainfall intensity and duration.
2. Area of the catchment.
3. Slope and shape of the catchment area.
4. Nature of the soil and the degree of porosity.
5. Initial state of the catchment.

If rainfall intensity and duration is more, large will be the quantity of storm water available. If the rainfall takes place very slowly even though it continues for the whole day, the quantity of storm water available will be less.

Harder surface yield more runoff than soft, rough surfaces. Greater the catchment area greater will be the amount of storm water. Fan shaped and steep areas contribute more quantity of storm water. In addition to the above it also depends on the temperature, humidity, wind etc.

### Estimate of quantity of storm water:

Generally there are two methods by which the quantity of storm water is calculated:

1. Rational method
2. Empirical formulae method

In both the above methods, the quantity of storm water is a function of the area, the intensity of rainfall and the co-efficient of runoff.

### Rational method:

Runoff from an area can be determined by the Rational Method. The method gives a reasonable estimate up to a maximum area of 50 ha (0.5 Km<sup>2</sup>).



**BMS INSTITUTE OF TECHNOLOGY AND MANAGEMENT**  
**YELAHANKA BANGALORE-560064**  
**DEPARTMENT OF CIVIL ENGINEERING**

### Assumptions and Limitations

Use of the rational method includes the following assumptions and limitations:

- Precipitation is uniform over the entire basin.
- Precipitation does not vary with time or space.
- Storm duration is equal to the time of concentration.
- A design storm of a specified frequency produces a design flood of the same frequency.
- The basin area increases roughly in proportion to increases in length.
- The time of concentration is relatively short and independent of storm intensity. The runoff coefficient does not vary with storm intensity or antecedent soil moisture.
- Runoff is dominated by overland flow.
- Basin storage effects are negligible.
- The minimum duration to be used for computation of rainfall intensity is 10 minutes. If the time of concentration computed for the drainage area is less than 10 minutes, then 10 minutes should be adopted for rainfall intensity computations.

This method is mostly used in determining the quantity of storm water. The storm water quantity is determined by the rational formula:

$$Q = \frac{C i A}{360}$$

Where,

Q= quantity of storm water in m<sup>3</sup>/sec

C= coefficient of runoff

i= intensity of rainfall

A= area of drainage in hectare

### Runoff coefficient:

In rational method, the value of runoff coefficient, C is required. The whole quantity of rain water that fall over the ground does not reach the sewer line. A portion of it percolates in the ground, a portion evaporates, a portion is stored in ponds and ditches and only remaining portion of rainwater reaches the sewer line. The runoff coefficient depends mainly on characteristics of ground surface as porosity, wetness, ground cover etc., which varies from 0.01 for forest or wooded area to 0.95 for a water tight roof surfaces.

As every locality consists of different types of surface area, therefore for calculating the overall runoff coefficient the following formula is used:

$$C = \frac{A_1 C_1 + A_2 C_2 + \dots + A_n C_n}{A_1 + A_2 + \dots + A_n}$$



**BMS INSTITUTE OF TECHNOLOGY AND MANAGEMENT**  
**YELAHANKA BANGALORE-560064**  
**DEPARTMENT OF CIVIL ENGINEERING**

=

Where:

C: Runoff coefficient

$A_1, A_2, A_3, \dots$  are different types of area

$C_1, C_2, C_3, \dots$  are their runoff coefficient respectively.

**Empirical formulae for rainfall intensities:**

The empirical formula given by British Ministry of Health is given by:

$$i = \frac{760}{t+10} \quad (\text{For storm duration of 5 to 20 minutes})$$

$$i = \frac{1020}{t+10} \quad (\text{For storm duration of 20 to 100 minutes})$$

Where

I - Intensity of rainfall, mm/h

t - Duration of storm, minutes

**Time of concentration of flow:**

The time taken for the maximum runoff rate to develop, is known as the time of concentration, and is equal to the time required for a drop of water to run from the farthest point of the watershed to the point for which the runoff is to be calculated.

The time of concentration,  $t_c$ , of a watershed is often defined to be the time required for a parcel of runoff to travel from the most hydraulically distant part of a watershed to the outlet. It is not possible to point to a particular point on a watershed and say, the time of concentration is measured from this point. Neither is it possible to measure the time of concentration. Instead, the concept of  $t_c$  is useful for describing the time response of a watershed to a driving impulse, namely that of watershed runoff.

In the context of the rational method then,  $t_c$  represents the time at which all areas of the watershed that will contribute runoff are just contributing runoff to the outlet. That is, at  $t_c$ , the watershed is fully contributing. We choose to use this time to select the rainfall intensity for application of the rational method. If the chosen storm duration is larger than  $t_c$ , then the rainfall intensity will be less than that at  $t_c$ . Therefore, the peak discharge estimated using the rational method will be less than the optimal value. If the chosen storm duration is less than  $t_c$ , then the watershed is not fully contributing runoff to the outlet for that storm length, and the optimal value will not be realized. Therefore, we choose the storm length to be equal to  $t_c$  for use in estimating peak discharges using the rational method.

The time of concentration refers to the time at which the whole area just contributes runoff to a point.

$$t_c = t_e + t_f$$

Where,



**BMS INSTITUTE OF TECHNOLOGY AND MANAGEMENT  
YELAHANKA BANGALORE-560064  
DEPARTMENT OF CIVIL ENGINEERING**

$t_c$  = time of concentration

$t_e$  = time of entry to the inlet (usually taken as 5 – 10 min)

$t_f$  = time of flow in the sewer

#### **1.4 Materials of sewers:**

Classification or types of sewers with respect to their material of construction:

The sewers may be made of:

1. Asbestos cement
2. Bricks
3. Cast iron
4. Cement concrete plain or reinforced
5. Corrugated iron sewers
6. Stoneware sewers
7. Steel sewers
8. Plastic sewers
9. Wooden sewers

May create beam action in the sewer line. To withstand all such effects, the sewer should be made from strong material.

#### **Types of sewers**

Different types of sewers are discussed

##### **Asbestos Cement Sewers**

- These are manufactured from a mixture of asbestos fibres, silica and cement. Asbestos fibers are thoroughly mixed with cement to act as reinforcement.
- These pipes are available in size 10 to 100 cm internal diameter and length up to 4.0 m.



**BMS INSTITUTE OF TECHNOLOGY AND MANAGEMENT**  
**YELAHANKA BANGALORE-560064**  
**DEPARTMENT OF CIVIL ENGINEERING**

- These pipes can be easily assembled without skilled labour with the help of special coupling, called Ring Tie Coupling or Simplex joint.
- The pipe and joints are resistant to corrosion and the joints are flexible to permit 12° deflection for curved laying.
- These pipes are used for vertical transport of water. For example, transport of rainwater from roofs in multi-storeyed buildings, for transport of sewage to grounds, and for transport of less foul sullage i.e., wastewater from kitchen and bathroom.

#### **Advantages**

- These pipes are light in weight and hence, easy to carry and transport.
- Easy to cut and assemble without skilled labour.
- Interior is smooth (Manning  $n = 0.011$ ) hence, can make excellent hydraulically efficient sewer.

#### **Disadvantages**

- These pipes are structurally not very strong.
- These are susceptible to corrosion by sulphuric acid. When bacteria produce  $H_2S$ , in presence of water,  $H_2SO_4$  can be formed.

**Bricks sewers:** Brick sewers are made it site. They are used for construction of large size sewers. Now a day's brick sewers are replaced by concrete sewers because lot of labour is involved in the construction of brick sewers. This material is used for construction of large size combined sewer or particularly for storm water drains. The pipes are plastered from outside to avoid entry of tree roots and ground water through brick joints. These are lined from inside with stone ware or ceramic block to make them smooth and hydraulically efficient. Lining also make the pipe resistant to corrosion.

**Cast Iron Sewers:** These pipes are stronger and capable to withstand greater tensile, compressive, as well as bending stresses. However, these are costly. Cast iron pipes are used for outfall sewers, rising mains of pumping stations, and inverted siphons, where pipes are running under pressure. These are also suitable for sewers under heavy traffic load, such as sewers below railways and highways. They are used for carried over piers in case of low lying areas. They form 100% leak proof sewer line to avoid ground water contamination. They are less resistant to corrosion; hence, generally lined from inside with cement concrete, coal tar paint, epoxy, etc. These are joined together by bell and spigot joint.

**Plain Cement Concrete or Reinforced Cement Concrete:** Plain cement concrete (1: 1.5: 3) pipes are available up to 0.45 m diameter and reinforcement cement pipes are available up to 1.8 m diameter. These pipes can be cast in situ or precast pipes. Precast pipes are better in quality than the cast in situ pipes. The reinforcement in these pipes can be different such as single cage reinforced pipes, used for internal pressure less than 0.8 m; double cage



**BMS INSTITUTE OF TECHNOLOGY AND MANAGEMENT**  
**YELAHANKA BANGALORE-560064**  
**DEPARTMENT OF CIVIL ENGINEERING**

reinforced pipes used for both internal and external pressure greater than 0.8 m; elliptical cage reinforced pipes used for larger diameter sewers subjected to external pressure; and hume pipes with steel shells coated with concrete from inside and outside. Nominal longitudinal reinforcement of 0.25% is provided in these pipes.

#### **Advantages of concrete pipes**

- Strong in tension as well as compression.
- Resistant to erosion and abrasion.
- They can be made of any desired strength.
- Easily moulded, and can be in situ or precast pipes.
- Economical for medium and large sizes.
- These pipes are available in wide range of size and the trench can be opened and backfilled rapidly during maintenance of sewers.

#### **Disadvantages**

- These pipes can get corroded and pitted by the action of  $H_2SO_4$ .
- The carrying capacity of the pipe reduces with time because of corrosion.
- The pipes are susceptible to erosion by sewage containing silt and grit.

The concrete sewers can be protected internally by vitrified clay linings. With protection lining they are used for almost all the branch and main sewers. Only high alumina cement concrete should be used when pipes are exposed to corrosive liquid like sewage.

**Corrugated iron sewers:** Corrugated iron sewers are used for storm sewers. The sewers should be protected from the effects of corrosion by galvanization or by bituminous coatings. They are made in varying metal thickness and in diameters upto 450cm.

**Plastic sewers:** (PVC pipes) Plastic is recent material used for sewer pipes. These are used for internal drainage works in house. These are available in sizes 75 to 315 mm external diameter and used in drainage works. They offer smooth internal surface. The additional advantages they offer are resistant to corrosion, light weight of pipe, economical in laying, jointing and maintenance, the pipe is tough and rigid, and ease in fabrication and transport of these pipes.

**High Density Polyethylene (HDPE) Pipes:** Use of these pipes for sewers is recent development. They are not brittle like AC pipes and other pipes and hence hard fall during loading, unloading and handling do not cause any damage to the pipes. They can be joined by welding or can be jointed with detachable joints up to 630 mm diameter (IS:4984-1987). These are commonly used for conveyance of industrial wastewater. They offer all the advantages offered by PVC pipes.

**Steel sewers:** These sewers are used where lightness, imperviousness and resistance to high pressure are the prime requirements. These sewers are flexible and can absorb vibrations and shocks efficiently. They are mainly used for trunk or outfall sewers. Riveting should, as far



**BMS INSTITUTE OF TECHNOLOGY AND MANAGEMENT**  
**YELAHANKA BANGALORE-560064**  
**DEPARTMENT OF CIVIL ENGINEERING**

as possible be avoided. These are used under the situations such as pressure main sewers, under water crossing, bridge crossing, necessary connections for pumping stations, laying pipes over self supporting spans, railway crossings, etc. They can withstand internal pressure, impact load and vibrations much better than CI pipes. They are more ductile and can withstand water hammer pressure better. These pipes cannot withstand high external load and these pipes may collapse when negative pressure is developed in pipes. They are susceptible to corrosion and are not generally used for partially flowing sewers. They are protected internally and externally against the action of corrosion.

**Vitrified Clay or Stoneware Sewers:** These pipes are used for house connections as well as lateral sewers. The size of the pipe available is 5 cm to 30 cm internal diameter with length 0.9 to 1.2 m. These pipes are rarely manufactured for diameter greater than 90 cm. These are joined by bell and spigot flexible compression joints.

#### **Advantages**

- Resistant to corrosion, hence fit for carrying polluted water such as sewage.
- Interior surface is smooth and is hydraulically efficient.
- The pipes are highly impervious.
- Strong in compression.
- These pipes are durable and economical for small diameters.
- The pipe material does not absorb water more than 5% of their own weight, when immersed in water for 24 h.

#### **Disadvantages**

- Heavy, bulky and brittle and hence, difficult to transport.
- These pipes cannot be used as pressure pipes, because they are weak in tension.
- These require large number of joints as the individual pipe length is small.

**Wooden sewers:** In early stages these sewers were put into use. They are difficult to construct and maintain. The life of sewers is short and they are now rarely in use.

#### **1.6 Shapes of Sewers:**

Sewers are generally circular pipes laid below ground level, slopping continuously towards the outfall. These are designed to flow under gravity. Mostly sewers of circular shape are used in all the sewerage schemes, because of the following facts:

- i. It affords least perimeter and hence construction material required is minimum.
- ii. They are easy to construct and handle.
- iii. Since it has no corners, there are less chances of deposition of organic matters.
- iv. They possess excellent hydraulic properties.

However, sewers of non circular shapes are used for the following reasons.





**BMS INSTITUTE OF TECHNOLOGY AND MANAGEMENT**  
**YELAHANKA BANGALORE-560064**  
**DEPARTMENT OF CIVIL ENGINEERING**

- (i) To develop self cleansing velocity in the sewer, when the flow is minimum.
- (ii) To effect economy in the construction.
- (iii) To increase the headway so that a man can enter easily for repairs, and cleaning.

Following are the non-circular shapes of sewers which are commonly used for sewers:

1. Box or rectangular sewers
2. Egg-shaped or avoid sewers
3. Basket-handle sections
4. Horse shoe sewers
5. Parabolic sewers
6. Semi-circular sewers
7. Semi-elliptical sewers
8. U-shaped sewers

**1. Box or rectangular type sewers:** In olden days these sewers were constructed by laying concrete at bottom and constructing the sides with masonry. But now a day's masonry has been completely replaced by concrete. These are mainly used for out fall sewers. They have got relatively high hydraulic mean depth at large flows and therefore can have higher velocities when laid to the same slope as that of a circular or egg-shaped sewer. They are therefore most suitable for large size storm sewers.

**2. Egg-shaped sewers:** These are shown in figure. This shape has got better hydraulic properties, but it is costly. Firstly due to longer perimeter more material for construction is required and secondly because of its odd shapes it is difficult to construct. This sewer requires always a good foundation and proper reinforcement to make structurally stable. In India they are rarely used. They are most suitable in case of combined sewers.

The main advantage of this sewer is that it gives a slightly higher velocity during low flow, than a circular sewer of the same size.

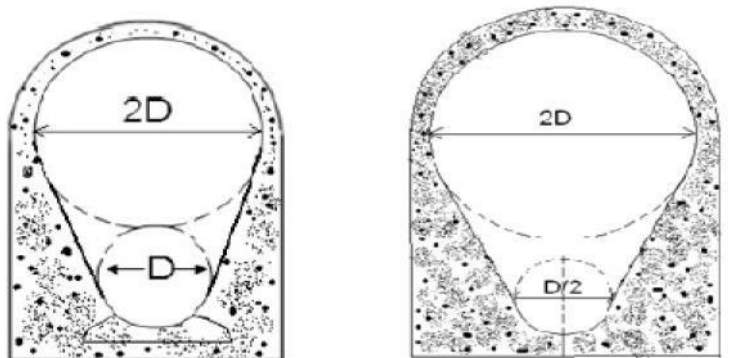

Standard Egg Shaped Sewer

New/ Modified Egg shaped Sewer



**BMS INSTITUTE OF TECHNOLOGY AND MANAGEMENT**  
**YELAHANKA BANGALORE-560064**  
**DEPARTMENT OF CIVIL ENGINEERING**

**3. Basket-handle sewer:** The shape of this sewer resembles the shape of a basket handle. Small discharges flow through the bottom narrower portion. During rainy days, the combined sewage flows in the full section.

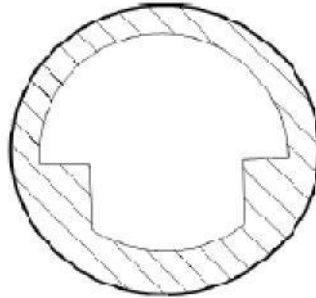

Basket-Handle Section

**4. Horse-shoe sewers:** Its top is usually semi-circular with sides inclined or vertical. The bottom may be flat, circular or paraboloid. Its height is more than width. It is mostly used for sewers in tunnels. It is used for the construction of large sewers with heavy discharges such as trunk sewers. This shape gives increased head room.

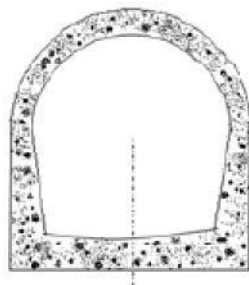

Horse shoe sewer section

**5. Parabolic sewers:** In this form of sewers, the upper arch takes the shape of parabola as shown in fig. The invert of the sewer may be flat, parabolic or elliptical. They are used for the disposal of relatively small quantities of sewage.

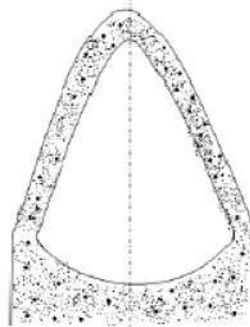

Parabolic section



**BMS INSTITUTE OF TECHNOLOGY AND MANAGEMENT  
YELAHANKA BANGALORE-560064  
DEPARTMENT OF CIVIL ENGINEERING**

**6. Semi-circular sewers:** The semi-circular sewer gives a wider care at the bottom and hence, it becomes suitable for constructing large sewers with less available headroom. Now a day there are replaced by rectangular sewers.

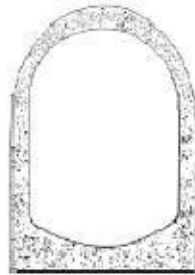

Semi-circular Section

**7. Semi-elliptical sewers:** This shape of sewer is more suitable for soft soils as they are more stable. This shape is not suitable for carrying low discharges and it is normally adopted for sewers having diameter greater than 180cm or so.

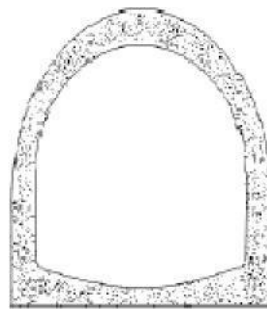

Semi-elliptical section

**8. U-shaped sewers:** Two sections of U-shaped sewers are shown in fig. Trench provided at the bottom is called cunete. These are easy to construct. Their invert may be flat or semi-circular. The sides are generally vertical and top may be flat or arched.

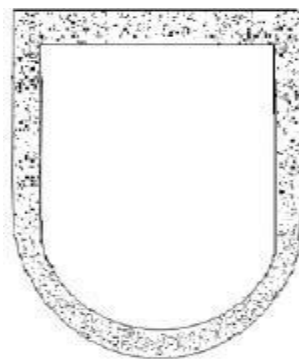

U-shaped section

### 1.7 Laying of Sewers:

After the sewer plan has been approved, the next step is to set out the work. The



**BMS INSTITUTE OF TECHNOLOGY AND MANAGEMENT**  
**YELAHANKA BANGALORE-560064**  
**DEPARTMENT OF CIVIL ENGINEERING**

centre line of the trench is first staked out on the ground. The centre line pegs are driven at a distance of 7.5m or 15m. The sight rail and boning rod system is the accepted method for laying the drains accurately to the gradients, indicated on the plans. Sight rails are set at all changes of gradients and at intermediate positions, if the distance for sighting is large. The sight rails are set in such a way that, the line sighted along the top edge of the rails represents, the true fall of the sewer, this gradient is shifted below the ground level by means of a Traveller of fixed length. Sight rails are the horizontal cross rails placed on uprights. They are

usually made up of a good straight piece of timber of 15cm width and 5cm thick and length to extend over the width of the trench. Traveller or boning rod contains of a rod and T-piece. It is most important that boning rod should be cut to the exact length required; otherwise the pipes may not be laid correctly to the required grade. The boning rod may be 8cm by 4cm timber piece of required length. A T-piece of 9cm by 45cm is securely fixed by nails at top (Fig 3.3). Since the work of laying pipes is generally started from the lower end, the sight rails will therefore, be required to fix at this point. After fixing the first set of sight rails at the lower end, a second set of sight rails is similarly set at some distance upstream side. Knowing the reduced level of invert of the sewer at the lower end and the desired gradient of the sewer line, the reduced level of invert at second set of sight rail is calculated. The depth of invert below both the sight rails should be the same to obtain the desired correct gradient, because the top of sight rails are adjusted to the correct reduced levels according to the gradient required.

### **Testing of sewer line**

It is necessary to test the sewer after its laying for water tightness before backfilling of the excavated earth.

**Smoke test:** This test is performed for soil pipes, vent pipes laid above ground. The test is conducted under a pressure of 2.5m of water and maintained for 15 minutes after all trap real have been filled with water. The smoke is produced by burning oil waste or tar paper in combustion chamber of a smoke machine.

**Water test:** This test is performed for underground sewer pipes before back filling is done. The test should be carried out by suitably plugging the lower end of the drain and filling the system with water. A knuckle band shall be temporarily jointed at the top end and a sufficient length of vertical pipe is jointed so as to provide the required test head.

Subsidence of test water may be due to (a) Absorption by pipes and joints (b) Leakages at joints etc. Any leakage if visible and defective part of work if any should be made good.

**Test for straightness and obstruction:** For this test, a mirror is placed in front of one end of sewer and the image of the section is observed. If the sewer line is straight, the image should be circular. If it is not a complete circle, then it is not straight. For testing for obstruction, by



**BMS INSTITUTE OF TECHNOLOGY AND MANAGEMENT**  
**YELAHANKA BANGALORE-560064**  
**DEPARTMENT OF CIVIL ENGINEERING**

inserting a steel call at upper end and if there is no obstruction in the sewer line, the call will emerge out from the

### Ventilation of Sewer

Sewage flowing in sewer has got lot of organic and inorganic matters present in it. Some of the matters decompose and produce gases. These gases are foul smelling, corrosive and explosive in nature. If these gases are not disposed of properly they may create a number of difficulties. They may cause air locks in sewers and affect the flow of sewage. They may prove to be dangerous for the maintenance squad working in sewers. They may also cause

explosions and put the sewer line out of commission. For the disposal of these gases, ventilation of sewer line is a must.

#### Methods of Ventilation

Following are some of the means or fittings which help in the ventilation of sewers,

1. Laying sewer line at proper gradient.
2. Running the sewer at half full or  $2/3$  depth.
3. Providing manhole with gratings.
4. Proper house drainage.
5. Providing the ventilating columns or shafts.

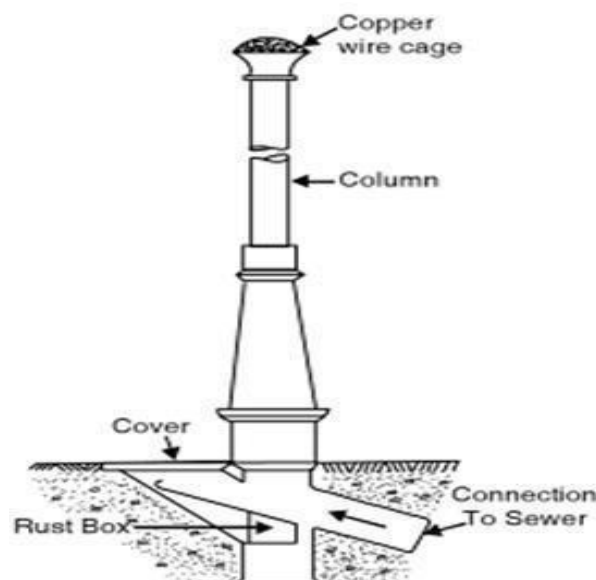

Fig. Ventilation column

### 1.8 Low-cost waste treatment:

**Oxidation pond:** Oxidation ponds, also called lagoons or stabilization ponds, are large, shallow ponds designed to treat wastewater through the interaction of sunlight, bacteria, and algae. Algae grow using energy from the sun and carbon dioxide and inorganic compounds released by bacteria in water. During the process of photosynthesis, the algae release oxygen



**BMS INSTITUTE OF TECHNOLOGY AND MANAGEMENT  
YELAHANKA BANGALORE-560064  
DEPARTMENT OF CIVIL ENGINEERING**

needed by aerobic bacteria. Mechanical aerators are sometimes installed to supply yet more oxygen, thereby reducing the required size of the pond. Sludge deposits in the pond must eventually be removed by dredging. Algae remaining in the pond effluent can be removed by filtration or by a combination of chemical treatment and settling.

**Advantages of oxidation Ponds**

1. Suitable for hot climate, where 200 sunny days are expected per year
2. Best suited for small cities and towns where land is cheap
3. Capital cost is only 20 to 30% of conventional plant
4. Maintenance cost is minor
5. No skilled supervision is required
6. Flexible and will get upset due to sudden fluctuations in organic loading

**Septic tank:** A tank, typically underground, in which sewage is collected and allowed to decompose through bacterial activity before draining by means of a soak away.

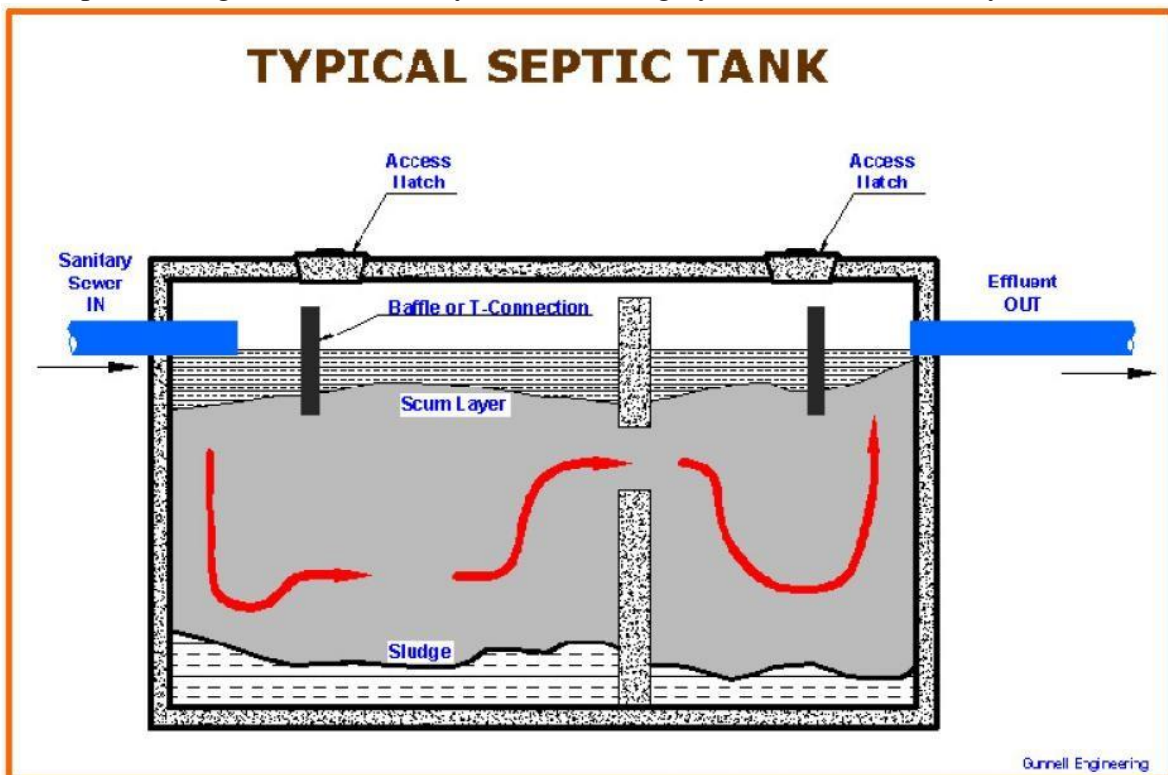

A septic tank is a watertight tank designed to slow down the movement of raw sewage and wastes passing through so that solids can separate or settle out and be broken down by liquefaction and anaerobic bacteria action. It does not purify the sewage, eliminate odours, or destroy all solid matter. The septic tank simply conditions the sewage so that it can be disposed of normally to a subsurface absorption system without prematurely clogging the system. Suspended solids removal is 50 to 70 percent; five-day BOD removal is about 60 percent.

The detention time for large septic tanks should not be less than 24 to 72 hr. Schools, camps, theatres, factories, and fairgrounds are examples of places where the total or a very



**BMS INSTITUTE OF TECHNOLOGY AND MANAGEMENT**  
**YELAHANKA BANGALORE-560064**  
**DEPARTMENT OF CIVIL ENGINEERING**

large proportion of the daily flow takes place within a few hours. For example, if the total daily flow takes place over a period of 6 hr (one-fourth of 24 hr), the septic tank should have a liquid volume equal to four times the 6-hr flow to provide a detention equivalent to 24 hr over the period of actual use. The larger tank would minimize scouring of septic tank sludge and scum and carryover of solids into the absorption system.

### 1.9 Sewer Appurtenances:

Sewage flowing in the sewer line contains a large number of impurities in the form of silt, fats, oils, rags etc. Under normal flows they are not likely to settle and choke the sewers, but during small flows self-cleansing velocity is not likely to develop and the chances of choking of the sewers are increased. Choking have to be removed time to time and facilities should be provided on the sewer lines for this purpose. Therefore, for proper functioning and to facilitate maintenance of the sewage system, various additional structures have to be constructed on the sewer lines. These structures are known as sewer appurtenances

Following are the important appurtenances, 1. Manholes 2. Inlets 3. Catch basins 4. Flushing devices 5. Regulators 6. Inverted siphons 7. Grease and oil traps 8. Lamp holes 9. Leaping weirs 10. Junction chambers

**Manholes:** The manholes are R.C.C or masonry chambers constructed on the sewer line to facilitate a man to enter the sewer line and make the necessary inspection and repairs. These are fitted with suitable cast iron covers. The manholes should be installed at every point where there is a change in direction, change in pipe size, or considerable change in gradient. As far as possible sewer line between two subsequent man holes should be straight. The centre distance between manholes is less for sewers of smaller size while it may behave such a size that man can easily enter in the working chamber. The minimum size is 50cm diameter.

Size of Sewer	Recommended spacing of Manhole
Dia up to 0.3 m	45 m
Dia up to 0.6 m	75 m
Dia up to 0.9 m	90 m
Dia up to 1.2 m	120 m
Dia up to 1.5 m	250 m
Dia greater than 1.5 m	300 m

### Classification of Manhole:

**Shallow Manholes (Inspection Manholes)** are the one which are about 0.75 to 0.9 m in depth. They are constructed at the start of a branch sewer.

**Normal Manholes** are those which are about 1.5 m in depth. They are constructed either in square (1 m \* 1m) or rectangular (0.8 m \* 1.2 m) in cross section.

**Deep Manholes** are those which are deeper than 1.5 m. The size of such a manhole is larger at the bottom, which is reduced at the top to reduce the size of manhole cover.



**BMS INSTITUTE OF TECHNOLOGY AND MANAGEMENT  
YELAHANKA BANGALORE-560064  
DEPARTMENT OF CIVIL ENGINEERING**

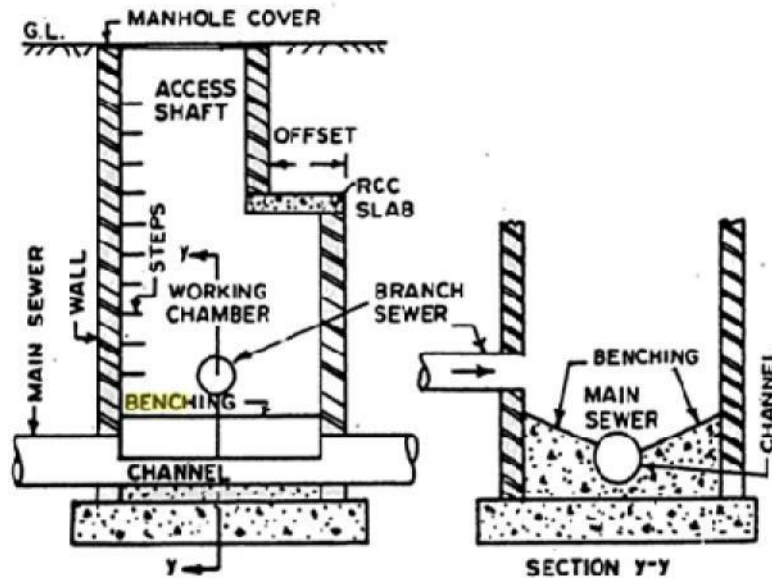
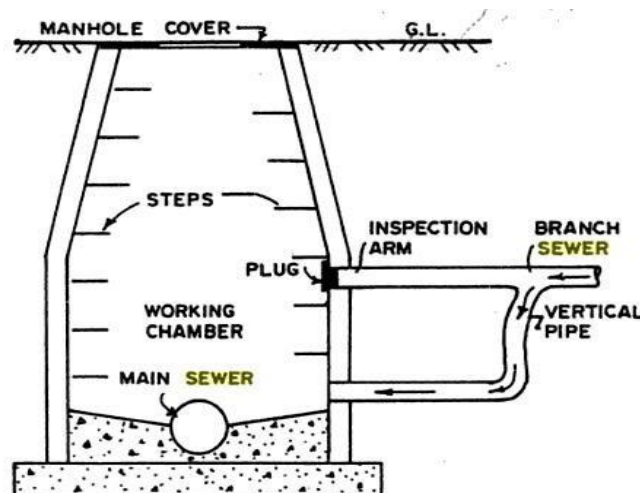

FIG. DEEP MANHOLE

**Drop Manhole:** It is a measure of connecting high level branch sewer to low level main sewer. They are connected through a vertical pipe. The installation of a drop manhole becomes necessary when there is difference in levels is more than 60cm between branch sewer and the main sewer, which can be avoided by increasing the sewer grade.

Components parts of a Deep Manhole are:

- i) Access shaft
- ii) Working chamber
- iii) Bottom or Invert
- iv) Side walls
- v) Steps or ladder
- vi) Top cover







**BMS INSTITUTE OF TECHNOLOGY AND MANAGEMENT**  
**YELAHANKA BANGALORE-560064**  
**DEPARTMENT OF CIVIL ENGINEERING**

**Catch Basins:** Catch basins are the structures of pucca chamber and a stout cover. They are meant for the retention of suspended grit, sludge and other heavy debris and floating rubbish from rain water which otherwise might have entered and cause choking problems. The outlet pipe from the catch basin may be submerged in order to prevent the escape of odours from the sewer and provision that also causes retention of floating matter. Their use is not recommended since they are more of a nuisance and a source of mosquito breeding apart from posing substantial maintenance problems.

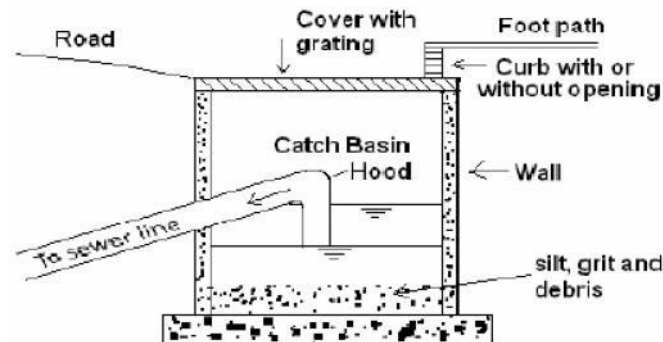

Catch Basins

**Basic principles of house drainage**

1. Lay sewers by the side of the building rather than below the building.
2. Drains should be laid straight between inspection chambers, avoiding sharp bends and junctions as far as possible
3. House drain should be connected to the public sewer only when public sewer is deeper than the house drain in order to avoid reverse flow.
4. Joints of sewer should be water tight and should be properly tested before putting the drainage line to use.
5. Lateral sewers should be laid at proper gradient so that they can develop self cleansing velocity.
6. Size of the drain should be sufficient so that they do not over flow at the time of maximum discharge.
7. Layout of the house drainage system should permit easy cleaning and removal of obstructions.
8. Entire system should be properly ventilated from the starting point to the final point of discharge
9. All the materials and fittings of the drainage system should be hard, strong and resistant to corrosion. They should be non-absorbent type.
10. The entire system should be so designed that the possibilities of formation of air locks,
11. Rain water pipes should drain water directly into the street gutters from where it is carried to the storm water drain.



**BMS INSTITUTE OF TECHNOLOGY AND MANAGEMENT**  
**YELAHANKA BANGALORE-560064**  
**DEPARTMENT OF CIVIL ENGINEERING**

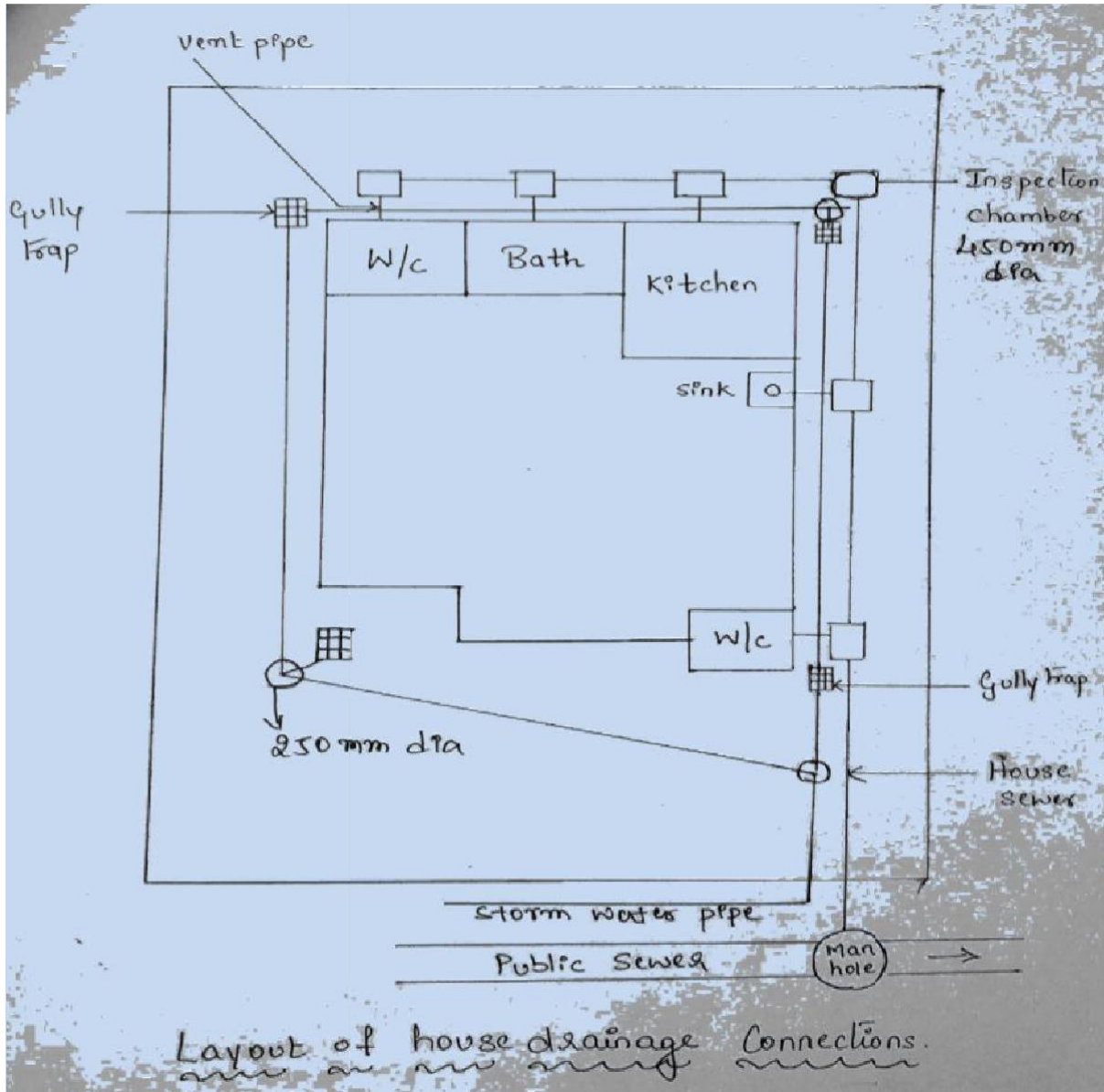



**BMS INSTITUTE OF TECHNOLOGY AND MANAGEMENT**  
**YELAHANKA BANGALORE-560064**  
**DEPARTMENT OF CIVIL ENGINEERING**

### 1.10 Recommended Questions

1. Explain the methods of sewage disposal.
2. Explain the types of sewerage system.
3. Explain the factors effecting DWF and WWF.
4. Write a note on
  - a) Oxidation pond
  - b) Septic tank
  - c) Manholes
  - d) Catch basins

### 1.11 Outcomes

1. Acquires capability to design sewer and Sewerage treatment plant.
2. Evaluate degree of treatment and type of treatment for disposal, reuse and recycle

### 1.12 Further Reading

1. <https://nptel.ac.in/courses/105106119/32>
2. <https://nptel.ac.in/courses/105105048/>
3. <https://nptel.ac.in/courses/105105048/M6L6.pdf>
4. <https://nptel.ac.in/courses/105105048/M13L17.pdf>

## Module – 2

### Introduction

#### Structure

- 2.0 Introduction
- 2.1 Objectives
- 2.2 Design of sewers
- 2.3 Effects of variation on velocity
- 2.4 Disposal of effluents by dilution
- 2.5 Oxygen sag curve
- 2.6 Sewage sickness
- 2.7 Recommended questions
- 2.8 Outcomes
- 2.9 Further Reading

#### 2.0 Introduction:

A sewerage system is a system that contains pipes of several lengths and diameters which are very important to convey the wastewater, including domestic, residential, industrial and commercial treatment services. Sewerage system plays a critical role in that it supports public health and environmental protection. Normally, the wastewater flow in the sewerage system is directly related to human usage for all kind of activities.

Sewerage system is a main consideration in any residential, commercial, and industrial development because it can enhance the environment through the disposal of wastewater. Moreover, it also can prevent floods through removal of rain water.

#### 2.1 Objectives

1. Understand sewerage network and influencing parameters.
2. Understand and design different unit operations involved in conventional and biological treatment process.
3. Evaluate self purification of streams depending on hydraulic and organic loading of sewage into receiving waters.

**2.2 Design of sewers:** After the determination of the quantity of sewage, variation in the quantity, the next step is to design the sewer section, which will be economical as well as can take the required discharge at self cleaning velocity.

**Estimate of sanitary sewage:** Sanitary sewage is mostly the spent water of the community draining into the sewer system with some ground water and a fraction into the sewer system with some ground water and a fraction of the storm runoff from the area, draining into it. The sewers should be capable of receiving the expected discharge at the end of design period. The provision however should not be much in excess of the actual discharge in the early years of its use to avoid depositions in sewers. The estimate of flow therefore requires a very careful consideration and is based upon the contributory population and the per-capita flow of sewage, both the factors being guided by the design period.

**Design period:** Since it is both difficult and uneconomical to augment the capacity of the system at a later date, sewers are usually designed for the maximum expected discharge to meet the requirements of the ultimate development of the area. A design period of 30 years for all types of sewers is recommended.

The future period for which the provision is made in designing the capacities of the various components of the sewerage scheme is known as the design period. The design period depends upon the following:

- Ease and difficulty in expansion,
- Amount and availability of investment,
- Anticipated rate of population growth, including shifts in communities, industries and commercial investments,
- Hydraulic constraints of the systems designed, and
- Life of the material and equipment.

Following design period can be considered for different components of sewerage scheme.

- Laterals less than 15 cm diameter : Full development
- Trunk or main sewers : 40 to 50 years
- Treatment Units : 15 to 20 years
- Pumping plant : 5 to 10 years

**Population estimate:** There are several methods for forecasting the population of a community. The most suitable approach is to base the estimation on anticipated ultimate density of population. Population is estimated based on the following methods.

- Arithmetical Increase Method
- Geometrical Increase Method
- Incremental Increase Method
- Graphical Method
- Comparative Graphical Method
- Master Plan Method
- Logistic Curve Method

**Area:** The tributary area for any section under consideration need to be marked on key plan. The topography, layout of buildings, legal limitations etc., determine the tributary area draining to a sewer section. The area is to be measured from the map.

**Per capita sewage flow:** Although the entire spent water of a community should contribute to the total flow in a sanitary sewer, it has been observed that a small portion is lost in evaporation, seepage in ground, leakage etc. Generally 80% of the water supply may be expected to reach the sewers. The sewers should be designed for a minimum of 150 lpcd.

**Ground water infiltration:** Estimate of flow in sanitary sewers may include certain flows due to infiltration of ground water through joints. The quantity will depend on the

workmanship in laying of sewers and the height of ground water table, the material of sewer, nature of soil etc. However the following values may be assumed.

- 5000-50000 liters/day/hectare.
- 500-5000 litre/day/km of sewers/cm of diameter.

**Self cleansing velocity:** It is necessary to maintain a minimum velocity in a sewer line to ensure that suspended solids do not deposit and cause choking troubles. Such a minimum velocity is called as self cleansing velocity. Self cleansing velocity is determined by considering the particle size and specific weight of the suspended solids in sewage.

The velocity which can cause automatic self cleansing can be found out by the following formula given by Shield:

$$V = \sqrt{\left[\left(\frac{8K}{f}\right) \left(\frac{Ss - S}{S}\right) g d\right]}$$

Where:

f = Darcy's co-efficient of friction, 0.03

K = characteristics of solid particles

= 0.06 for organic and

= 0.04 for inorganic solids

Ss = specific gravity of particles

= 2.65 for inorganic and

= 1.2 for organic solids

S = specific gravity of sewage, 1.0

G = acceleration due to gravity

D = diameter of particle As per

### Maximum Velocity or Non-scouring Velocity

The interior surface of the sewer pipe gets scored due to the continuous abrasion caused by suspended solids present in sewage. The scoring is pronounced at higher velocity than what can be tolerated by the pipe materials. This wear and tear of the sewer pipes will reduce the life span of the pipe and their carrying capacity. In order to avoid this, it is necessary to limit the maximum velocity that will be produced in sewer pipe at any time. This limiting or non-scouring velocity mainly depends upon the material of sewer.

Sewer	Material Limiting velocity, m/sec
Vitrified tiles	4.5 – 5.5
Cast iron sewer	3.5 – 4.5
Cement concrete	2.5 – 3.0
Stone ware sewer	3.0 – 4.5
Brick lined sewer	1.5 – 2.5

### 2.3 Effect of Flow Variations on Velocities in a Sewer:

The discharge flowing through sewers varies considerably from time to time. Hence, there occur variation in depth of flow and thus, variation in Hydraulic Mean Depth (H.M.D.). Due to change in H.M.D. there occur changes in flow velocity, because it is proportional to (H.M.D.)<sup>2/3</sup>. Therefore, it is necessary to check the sewer for minimum velocity of about 0.45

m/sec at the time of minimum flow (1/3 of average flow) and the velocity of about 0.9 to 1.2 m/sec should be developed at a time of average flow. The velocity should also be checked for limiting velocity i.e. non-scouring velocity at the maximum discharge.

For flat ground sewers are designed for self-cleansing velocity at maximum discharge. This will permit flatter gradient for sewers. For mild sloping ground, the condition of developing self-cleansing velocity at average flow may be economical. Whereas, in hilly areas, sewers can be designed for self-cleansing velocity at minimum discharge, but the design must be checked for non-scouring velocity at maximum discharge.

### Regime velocity:

- i. Channel should flow uniformly in “incoherent unlimited alluvium” of same character as that transported by the water;
- ii. Silt grade and silt charge should be constant; and
- iii. Discharge should be constant.

These conditions are very rarely achieved and are very difficult to maintain in practice. Hence according to Lacey’s conception regime conditions may be subdivided as initial and final. The definitions of these two terms are already given earlier.

In rivers achievement of initial or final regime is practically impossible. Only in bank full stage or high floods the river may be considered to achieve temporary or quasi-regime. The recognition of this fact can be utilised to deal with the issues concerning scour and floods.

Lacey also a state that the silt is kept in suspension solely by force of eddies. But Lacey adds that eddies are not generated on the bed only but at all points on the wetted perimeter. The force of eddies may be taken normal to the sides

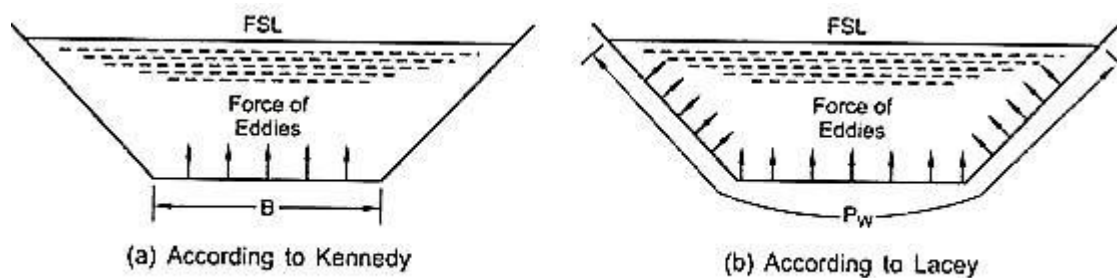

Fig. 9.2. Lacey's theory

Obviously the vertical components of forces due to eddies are responsible for keeping the silt in suspension. Unlike Kennedy, Lacey takes hydraulic mean radius ( $R$ ) as a variable rather than depth ( $D$ ). So far as wide channels are concerned there is hardly any difference between  $R$  and  $D$ . When the channel section is semi-circular there is no base width and sides actually and hence assumption of  $R$  as a variable seems to be more logical. From this point of view velocity is no more dependent on  $D$  but, rather depends on  $R$ . Consequently amount of silt transported is not dependent on the base width of a channel only.

$$V = K R^{1/2}$$

Where,  $V$  = Regime velocity

R = hydraulic mean radius

K = constant.

## 2.4 Disposal of effluents by dilution

### 1. Dilution i.e., disposal of sewage to water.

#### 2. Land disposal.

Both the methods are very simple. But these may be regulated carefully so that, the quantity of sewage discharged into water or applied to land is such that they are capable of receiving the organic load present in the effluent.

**Dilution:** Dilution is the disposal of sewage by discharging it into large bodies of water like sea, streams, rivers etc. This method is possible only when the natural water is available in large quantity near the town. Proper care should be taken while discharging sewage in water so that sewage may not pollute natural water and make it unfit for any other purposes like bathing, drinking, irrigation etc.

#### Conditions Favourable for Dilution:

1. Where sewage is fresh.
2. Where favourable currents exits in a stream.
3. Where sewage is almost free from floating/ settleable solids.
4. Where thorough mixing is possible.
5. Where diluting water has high quantities of dissolved oxygen.
6. When the city is situated near river or sea.

#### Conditions Essential for treatment before Dilution:

- Where wastewater is harmful to aquatic life
- Where wastewater is contains industrial wastes containing toxic substances
- Where receiving waters are used for inland navigation
- Where receiving water is a source for drinking
- Where wastewater is not fresh but is stale,
- Where wastewater is not likely to be dispersed easily due to tides, winds, cross-currents etc.

#### Self Purification Phenomenon:

**Self Purification of Natural Streams:** The automatic purification of natural water is known as self purification. The self purification of natural water systems is a complex process that often involves physical, chemical, and biological processes working simultaneously. When wastewater is discharged into a natural stream, the organic matter is broken down by bacteria to ammonia, nitrates, sulphates, carbon-dioxide etc. In this process of oxidation, the dissolved oxygen content of water is utilized. Due to this, deficiency of DO is created. As the excess organic matter is stabilized, the normal cycle will be re-established wherein the oxygen is replenished by its re-aeration. This process is known as Self-Purification. Also, the stabilized by products of oxidation mentioned earlier are utilized by plants, algae to produce carbohydrates and oxygen.



The amount of dissolved Oxygen (DO) in water is one of the most commonly used indicators of a river health. As DO drops below 4 or 5 mg/L the forms of life that can survive begin to be reduced. A minimum of about 2.0 mg/L of dissolved oxygen is required to maintain higher life forms.

**Factors affect the amount of DO available in a river:**

- Oxygen demanding wastes remove DO
- Plants add DO during day but remove it at night
- Respiration of organisms removes oxygen.
- In summer, rising temperature reduces solubility of while lower flows reduce the rate at which oxygen enters the water from atmosphere.

**Factors Affecting Self Purification:**

**Dilution:** When wastewater is discharged into the receiving water, dilution takes place due to which the concentration of organic matter is reduced and the potential nuisance of swage is also reduced. If  $C_S$  and  $C_R$  are the concentrations of an impurity such as organic content, BOD, suspended solids in the sewage and river having discharge rates  $Q_S$  and  $Q_R$  respectively, the resulting concentration  $C$  of the diluted mixture is given by,

$$C_S Q_S + C_R Q_R = C (Q_S + Q_R)$$

$$C = \frac{C_S Q_S + C_R Q_R}{Q_S + Q_R}$$

When the dilution ratio is quite high, large quantities of DO are always available which will reduce the chances of putrefaction (disintegration) and pollution effects. Aerobic condition always exists because of dilution. This will however not be there, if dilution ratio is small, i.e. when large quantities of effluent is discharged into a small stream.

**Water Current:** When strong water current is available, the discharged wastewater will be thoroughly mixed with stream water preventing deposition of solids. In small current, the solid matter from the wastewater will get deposited at the bed following decomposition and reduction in DO.

**Temperature:** The quantity of DO available in stream water is more in cold temperature than in hot temperature. Also, as the activity of microorganisms is more at the higher temperature, hence, the self-purification will take less time at hot temperature than in winter.

**Sunlight:** Algae produces oxygen in presence of sunlight due to photosynthesis. Therefore, sunlight helps in purification of stream by adding oxygen through photosynthesis.

**Rate of Oxidation:** Due to oxidation of organic matter discharged in the river DO depletion occurs. This rate is faster at higher temperature and low at lower temperature. The rate of oxidation of organic matter depends on the chemical composition of organic matter.

**Zones of pollution in the stream:**

The self-purification process of stream polluted by wastewater discharged into it can be divided into the following four zones:

**1. Zone of degradation:** This zone is situated below the outfall sewer when discharging its contents into stream. In this zone, water is dark and turbid, having the formation of sludge deposits at the bottom. The DO is reduced to 40% of the saturation values. There is an increase in CO<sub>2</sub> content and re-aeration is much slower than de-oxygenation. Though conditions are unfavourable for aquatic life, fungi at higher points and bacteria at lower points breed small which stabilizes the sewage sludge. The decomposition of solid matter takes place in this zone and anaerobic decomposition prevails.

**2. Zone of active decomposition:** This zone is just after the degradation zone and is marked by heavy pollution. Water in this zone becomes greyish and darker than previous zone. The DO concentration in this zone falls down to zero. Active anaerobic organic decomposition takes place, with the evolution of methane (CH<sub>4</sub>), hydrogen sulphide (H<sub>2</sub>S), carbon-dioxide (CO<sub>2</sub>) and nitrogen (N<sub>2</sub>), bubbling to the surface with masses of sludge forming black scum. Fish life is absent in this zone and, anaerobic bacteria at the upper end and aerobic bacteria at the lower end.

However, at the end of this zone, as the decomposition slackens, reaeration sets in and DO again rises to its original level of 40%.

**3. Zone of recovery:** In this zone, the process of recovery starts, from its degraded condition to its former condition. The stabilization of organic matter takes place in this zone. Due to this, most of the stabilized organic matter settles as sludge, BOD falls and DO content rises above the 40% value. Mineralization is active, with the resulting formation of products like nitrates (NO<sub>4</sub>), sulphates (SO<sub>4</sub>), carbonates (CO<sub>3</sub>). Near the end of the zone, microscopic aquatic life reappears, fungi decreases and algae reappears.

**4. Clear water zone:** In this zone, the natural condition of stream is resorted with the result that

- Water becomes clearer and attractive in appearance,
- DO rises to the saturation level, and is much higher than BOD
- Oxygen balance is attained.

Thus recovery is said to be complete in this zone, though some pathogenic organisms may be present in this zone.

**Indices of Self-Purification method:**

The stage of self-purification process can be determined by physical, chemical and biological analysis of the water. Colour and turbidity are the physical indices, while DO, BOD and suspended solids are the chemical indices which can mark the stages of purification. Moreover, the biological growth present in the water can also indicate the stage of

purification process, as different types of micro and macro organisms will exist in polluted water under different conditions.

### 2.5 Oxygen Sag Curve:

The oxygen sag or oxygen deficit in the stream at any point of time during self purification process is the difference between the saturation DO content and actual DO content at that time.

OR

The amount of resultant oxygen deficit can be obtained by algebraically adding the de-oxygenation and re-oxygenation curves. The resultant curve so obtained is called oxygen sag curve

$$\text{Oxygen Deficit, } D = \text{Saturation DO} - \text{Actual DO}$$

The saturation DO value for fresh water depends upon the temperature and total dissolved salts present in it and its value varies from 14.62 mg/L at 0°C to 7.63 mg/L at 30°C, and lower DO at higher temperatures.

The DO in the stream may not be at saturation level and there may be initial oxygen deficit (D). At this stage, when the effluent with initial BOD load  $L_0$ , is discharged into stream, the DO content of the stream starts depleting and the oxygen deficit (D) increases. The variation of oxygen deficit (D) with the distance along the stream, and hence with the time of flow from the point of pollution is depicted by the Oxygen Sag Curve. The major point in sag analysis is point of minimum DO, i.e., maximum deficit. The maximum or critical deficit ( $D_c$ ) occurs at the inflexion points (as shown in fig) of the oxygen sag curve.

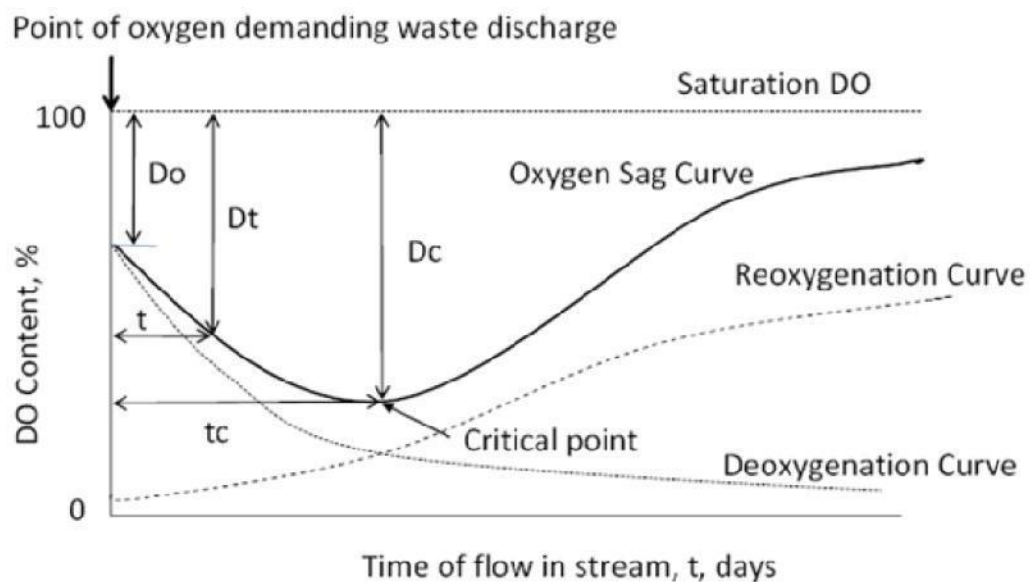

Deoxygenation, reoxygenation and oxygen sag curve

### De-oxygenation and Re-oxygenation Curves:

**De-oxygenation curve:** The curve which represents (or) showing the depletion of D.O with time at the given temperature.

**Re-oxygenation Curve:** In order to counter balance the consumption of D.O due to the de – oxygenation, atmosphere supplies oxygen to the water and the process is called the re – oxygenation.

When wastewater is discharged in to the stream, the DO level in the stream goes on depleting. This depletion of DO content is known as de-oxygenation. The rate of de-oxygenation depends upon the amount of organic matter remaining (Lt), to be oxidized at any time t, as well as temperature (T) at which reaction occurs. The variation of depletion of DO content of the stream with time is depicted by the de-oxygenation curve in the absence of aeration. The ordinates below the de-oxygenation curve indicate the oxygen remaining in the natural stream after satisfying the bio-chemical demand of oxygen. When the DO content of the stream is gradually consumed due to BOD load, atmosphere supplies oxygen continuously to the water, through the process of re-aeration or re-oxygenation, i.e., along with de-oxygenation, re-aeration is continuous process.

### **Dilution into Sea:**

The saturation concentration of the dissolved oxygen in water decreases with increase in salt content. Due to this reason, the saturation concentration in sea water is approximately 80% of that in water. In addition to this deficiency, the temperature of sea water is lower than sewage temperature, whereas the specific gravity is higher. Due to these reasons, when sewage is discharged into sea water, the lighter and warmer sewage will rise up to the surface, resulting in the spreading of the sewage at the top surface of sea in a thin film or sleek. Moreover, sea water contains a large amount of dissolved matter which chemically reacts with the swage solids, resulting in the precipitation of some of the sewage solids, giving a milky appearance to the sea water and resulting in the formation of sludge banks. These sludge banks and thin milky layer formed at the top of sea water produces offensive hydrogen sulphide gas by reacting with the sulphate rich water of the sea. The various chemical reactions and the prevailing dissolved matter in the sea water reduce its capacity to absorb more quantity of sewage. However, since the sea contains large volume of water, most of these deficiencies can be overcome if the sewage is discharged deep into the sea, much away from the coast line, with extreme care.

The following points should be kept in mind

1. The sewage should be discharged deep into the sea, preferably 1 to 1.5km away from the shore.
2. The outfall should be so designed such that there should be proper dilution of waste with seawater before waste tries to come to the surface.
3. The minimum depth of water at the outfall point should be 3 to 5m.
4. The sewage should be disposed off only during the low tides. For this purpose tanks of large size should be constructed near the shore during high tides and release the same during low tides.
5. While designing the position of outfall, the direction of wind velocity and direction of ocean currents should be considered.

### Disposal by land treatment:

When the wastewater, either raw or partly treated, is applied or spread on the surface of land, the method is called disposal by land treatment. Some part of the wastewater evaporates while other part percolates into the ground leaving behind suspended solids which are partly acted upon by the bacteria and partly oxidized by exposure to atmospheric actions of air, heat and light. The sewage adds to the fertilizing value of the land, and crops can be profitably raised on such land. Due to this, the disposal by land treatment is also known as sewage farming.

The three principal process of land treatment of wastewater are:

1. Broad irrigation or sewage farming
2. Rapid infiltration
3. Overland runoff

The first two processes depend upon the moving or percolating the water downward through the soil and thus are limited by infiltration and percolating capacity of the land. While the percolating capacity is a function of soil characteristics, the infiltration depends upon the degree of clogging at the soil surface. If the waste is sufficiently pretreated, clogging will be minimized and percolation will limit the rate at which liquid can be applied. For percolation of 6 to 25mm/min - rapid infiltration is practicable, for 2 to 6mm/min – broad irrigation is suited and below 2mm/min overland runoff should be adopted.

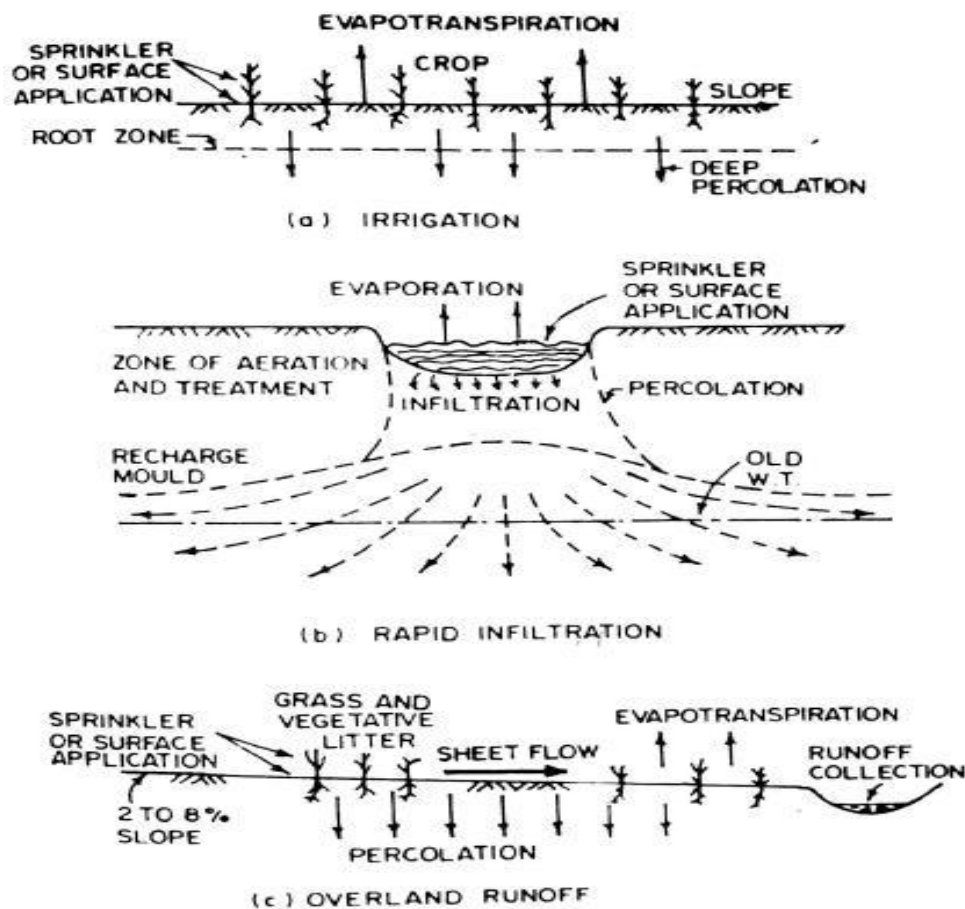

Rapid infiltration may be used for waste disposal, ground water recharge or both. For this process, wastewater is discharged into large basin underlined by soils and sands of high permeability. Bottom of the basin may be covered with grass which assists in removal of nitrogen gas and helps in maintaining the infiltration capacity of the surface.

The technique of overland runoff is applied when soils have low permeability. It is not a true disposal system since wastewater must be collected after passage over the soil. Plant or tree cover is essential to minimize and assist in nutrient removal. Thus for this purpose grasses are grown. The complex compounds in the sewage are thus converted into harmless mineral salts which serve as valuable fertilizers. The nutrients in the sewage like nitrogen, phosphorous and potassium along with the micro-nutrients as well as organic matter present in it could be advantageously employed for sewage farming to add the fertility of the soil.

#### **Methods of application of wastewater:**

- Sprinkler irrigation method
- Subsurface irrigation method
- Surface irrigation method

In sprinkler irrigation method, sewage is spread over the soil through nozzles which are fitted at the tips of pipes carrying sewage under pressure. The process, being costly is not preferred in India, although it gives very good results, like those of natural rainfall.

In sub-surface irrigation method, sewage is applied directly to the root zone of crops, though a system of properly laid open-jointed pipes. Sewage as it flows through these pipes, exfiltrates through the open joints and is distribute in the surrounding area by the action of capillarity.

Surface irrigation method is also known as Broad irrigation, where swage is applied over the surface of the land. There are different methods of application of sewage to the land are as follows:

i) **Border strip method:** In this method, agricultural field is divided into series of strips of width varying from 10 to 20m and length varying from 100 to 300m with a slope of 0.5 to 1.5%. Each strip is separated by means of borders or levels. Sewage is supplied between those borders from the main ditch through the inlet provided at the head of each strip and is made to flow in the form of sheets. The discharge to be supplied at the supply ditch depends on type of soil.

ii) **Free flooding:** This method is also known as irrigation by plots which are commonly used in India. In this method the entire field is divided into number of small plots which are relatively flat. The sewage is supplied from main ditch or supply ditch to subsidiary ditch to higher end of each plot. The supply is cutoff as soon as the plot receives sufficient depth of sewage

iii) **Basin flooding:** This method is used for irrigating orchards. In this method each tree or a group of tree is included by a circular channel, which is called as basin. These basins are supplied with sewage from the main ditch through field canals

iv) **Check flooding:** This method consists of applying sewage to check basins enclosed by a small size bunds (checks). The size of checks varies from 3m x 3m to 30m x 30m depending upon the type of soil and type of crop.

v) **Furrow irrigation method:** This method is adopted for row crops such as sugarcane, maize, tobacco and some variety of vegetables. In this method, sewage is supplied in furrows between crop rows. Sewage spreads laterally irrigating the area between two furrows. The width of furrow varies from 120-150 cm and the depth from 25-50 cm. The width of the ridge varies from 125-250 cm and length from 10-30 m. The percolated effluent is collected in underground drains flows towards natural drainage for disposal.

#### **Advantages of Sewage farming:**

1. Adds manure to land
2. Pollution of natural water courses is minimized.
3. Increase fertility of land.
4. Gives high calorific value to crops grown in sewage farms.
5. Does not require any installation of equipment involving high initial cost.
6. Crops could be grown and hence a return value is always possible to obtain.
7. Method specially suitable where large quantity of river water is not available at all times of the year.

#### **Disadvantages of Sewage farming:**

1. Difficult to get land during rainy and harvest seasons.
2. Additional land is required for reserve.
3. Sanitary reasons may not permit growing of crops on sewage farms.
4. More land area is required if sewage volume is greater since land capacity is limited.
5. If all precautions are not taken, sewage farming results in sewage sickness to land and health to life.

#### **Conditions favourable for land treatment:**

- 1) When natural rivers are not located near the town or city.
- 2) When river runs dry or have a small flow during summer, discharging sewage into them is out of question.
- 3) When plentiful land with sandy, loamy or alluvial soil overlying soft murrum, sand or gravel is available, land treatment is favoured.
- 4) When climate is arid (means dry), land treatment is favoured.
- 5) Land treatment is favoured when subsoil water table is low even in wet season.
- 6) Land treatment is favoured when rainfall is low.
- 7) When large open areas are available near the locality, broad irrigation can be easily practiced.
- 8) Cash crops can be easily grown on sewage farms.

#### **2.6 Sewage Sickness:**

The phenomena of soil getting clogged and loses its capacity of receiving the sewage load when the sewage is applied continuously on a piece of land is called sewage sickness.

Sewage sickness can be prevented by adopting the following measures:

- **Pre-treatment of sewage:** By giving primary treatment to the sewage, the suspended solids are removed. Due to this measure, the pores of the soil will not get clogged quickly. Also, BOD load will be reduced by 30%.
- **Provision of extra land:** Extra land, as reserve or standby should be available so that the land with sewage sickness can be given rest. During the rest period, the sick land should be properly ploughed so that it is broken up and aerated.
- **Under Drainage of soil:** Subsoil drains should be provided to collect the percolated wastewater. This will minimize the possibility of sewage sickness.
- **Proper choice of land:** The land chosen for this purpose should be sandy or loamy, having higher permeability. Clayey soil should be avoided.
- **Rotation of crops:** Rotation of crops minimizes the chances of sewage sickness and prevents soil erosion and improves the fertility of land.
- **Shallow depth application:** Sewage should be applied in shallow depths. If sewage is applied at greater depths, chances of sewage sickness are increases.

### 2.7 Recommended Questions

1. Write a note on oxygen sag curve
2. Write a note on sewage sickness.
3. Explain the factors to be considered while designing sewers.
4. Explain the effects of variation on velocity.



## Module – 3

### Introduction

#### Structure

- 3.0 Introduction
- 3.1 Objectives
- 3.2 Sampling
- 3.3 Characteristics of wastewater
- 3.4 Flow diagram for municipal waste water treatment
- 3.5 Unit operations
- 3.6 Trickling filters
- 3.7 Activated sludge process
- 3.8 Sequential batch reactors
- 3.9 Moving bed bio reactors
- 3.10 Sludge digesters
- 3.11 Recommended questions
- 3.12 Outcomes
- 3.13 Further Reading

#### 3.0 Introduction

The objective of sampling is to collect representative sample. Representative sample by means a sample in which relative proportions or concentration of all pertinent components will be the same as in the material being sampled. Moreover, the same sample will be handled in such a way that no significant changes in composition occur before the tests are made. The sample volume shall optimal small enough that it can be transported and large enough for analytical purposes. Because of the increasing placed on verifying the accuracy and representatives of data, greater emphasis is placed on proper sample collection, tracking, and preservation techniques. Often laboratory personnel help in planning a sampling program, in consultation with the user of the test results. Such consultation is essential to ensure selecting samples and analytical methods that provide a sound and valid basis for answering the questions that prompted the sampling and that will meet regulatory and/or project-specific requirements.

#### 3.1 Objectives

- Understand and design different unit operations involved in conventional and biological treatment process.

#### 3.2 Sampling:

The objective of sampling is to collect representative sample. Representative sample by means a sample in which relative proportions or concentration of all pertinent components will be the same as in the material being sampled. Moreover, the same sample will be handled in such a way that no significant changes in composition occur before the tests are made. The sample volume shall optimal small enough that it can be transported and large enough for analytical purposes. Because of the increasing placed on verifying the accuracy

and representatives of data, greater emphasis is placed on proper sample collection, tracking, and preservation techniques. Often laboratory personnel help in planning a sampling program, in consultation with the user of the test results. Such consultation is essential to ensure selecting samples and analytical methods that provide a sound and valid basis for answering the questions that prompted the sampling and that will meet regulatory and/or project-specific requirements.

The objectives and significance must be clearly understood when environmental sampling is carried out. Field records and analysis data obtained using analytical instruments are required if we are to correctly evaluate the environmental situation, and such data must be representative of the environment. In order to obtain accurate environmental data, it is imperative that the analysis samples be representative. However, they are not particularly easy to collect, so can only be accumulated through appropriate planning and implementation of sampling.

In terms of types of aquatic sampling, we include river water, seawater, and factory effluent sampling. With regard to air sampling, we look at flue gases from factories and vehicles, as well as ambient air sampling. Sometimes riverbeds are also sampled.

As stated before, the most important issue when drawing up a plan for sampling is to clearly understand its significance and objectives. In other words, we must correctly determine how, why, and what to conduct the survey on. Furthermore, sampling work should be undertaken according to specified procedures. In this case, it is important to use samplers and sample containers that are suited to the task.

Regular surveys are required to provide successive sampling analysis data in order to identify environmental changes, so such sampling must be consistent in its methodology and location. A very high degree of accuracy is required when undertaking sampling to determine whether the law is being met. When sampling under accident conditions, data should be obtained to accurately establish the cause(s) and evaluate the state of the site in order to discuss appropriate countermeasures.

### 3.2.1 Sampling Techniques

Two types of sampling techniques are used: grab and composite.

**Grab samples:** Grab samples are single collected at a specific spot at a site over a short period of time (typically seconds or minutes). Thus, they represent a —snapshot in both space and time of a sampling area. Discrete grab samples are taken at a selected location, depth, and time. Depth-integrated grab samples are collected over a predetermined part of the entire depth of a water column, at a selected location and time in a given body of water. Grab samples consist of either a single discrete sample or individual samples collected over a period of time not to exceed 15 minutes. The grab sample should be representative of the wastewater conditions at the time of sample collection. The sample volume depends on the type and number of analyses to be performed. A sample can represent only the composition of its source at the time and place of collection. However, when a source is known to be relatively constant in composition over an extended time or over substantial distances in all directions, then the sample may represent a longer time period and/or a larger volume than the specific time and place at which it was collected. In such circumstances, a source may be represented adequately by single grab samples. Examples are protected groundwater supplies,

water supplies receiving conventional treatment, some well-mixed surface waters, but rarely, wastewater streams, rivers, large lakes, shorelines, estuaries, and groundwater plumes. When a source is known to vary with time, grab samples collected at suitable intervals and analyzed separately can document the extent, frequency, and duration of these variations. Choose sampling intervals on the basis of the expected frequency of changes, which may vary from as little as 5 min to as long as 1h or more. Seasonal variations in natural systems may necessitate sampling over months. When the source composition varies in space (i.e. from location to location) rather than time, collect samples from appropriate locations that will meet the objectives of the study (for example, upstream and downstream from a point source, etc.).

**Composite samples:** Composite samples should provide a more representative sampling of heterogeneous matrices in which the concentration of the analytes of interest may vary over short periods of time and/or space. Composite samples can be obtained by combining portions of multiple grab samples or by using specially designed automatic sampling devices. Sequential (time) composite samples are collected by using continuous, constant sample pumping or by mixing equal water volumes collected at regular time intervals. Flow-proportional composites are collected by continuous pumping at a rate proportional to the flow, by mixing equal volumes of water collected at time intervals that are inversely proportional to the volume of flow, or by mixing volumes of water proportional to the flow collected during or at regular time intervals. Advantages of composite samples include reduced costs of analyzing a large number of samples, more representative samples of heterogeneous matrices, and larger sample sizes when amounts of test samples are limited. Disadvantages of composite samples include loss of analyte relationships in individual samples, potential dilution of analytes below detection levels, increased potential analytical interferences, and increased possibility of analyte interactions. In addition, use of composite samples may reduce the number of samples analyzed below the required statistical need for specified data quality objectives or project-specific objectives.

Do not use composite samples with components or characteristics subject to significant and unavoidable changes during storage. Analyze individual samples as soon as possible after collection and preferably at the sampling point. Examples are dissolved gases, residual chlorine, soluble sulphide, temperature, and pH. Changes in components such as dissolved oxygen or carbon dioxide, pH, or temperature may produce secondary changes in certain inorganic constituents such as iron, manganese, alkalinity, or hardness. Some organic analytes also may be changed by changes in the foregoing components. Use time-composite samples only for determining components that can be demonstrated to remain unchanged under the conditions of sample collection, preservation, and storage. Collect individual portions in a wide-mouth bottle every hour (in some cases every half hour or even every 5 min) and mix at the end of the sampling period or combine in a single bottle as collected. If preservatives are used, add them to the sample bottle initially so that all portions of the composite are preserved as soon as collected. Automatic sampling devices are available; however, do not use them unless the sample is preserved as described below. Composite samplers running for extended periods (week to months) should undergo routine cleaning of containers and sample lines to minimize sample growth and deposits. Composite samples are

collected over time, either by continuous sampling or by mixing discrete samples. A composite sample represents the average wastewater characteristics during the compositing period. Various methods for compositing are available and are based on either time or flow proportioning. The choice of a flow proportional or time composite sampling scheme depends on the permit requirements, variability of the wastewater flow or concentration of pollutants, equipment availability and sampling location. The investigator must know each of these criteria before a sampling program can be initiated. Generally, a time composite is acceptable. However, in enforcement cases where strict adherence to permit requirements are necessary, a flow proportional sample is preferable, if possible. A time composite sample consists of equal volume discrete sample aliquots collected at constant time intervals into one container. A time composite sample can be collected either manually or with an automatic sampler. A flow proportional composite sample can be collected using one of two methods. One method consists of collecting a constant sample volume at varying time intervals proportional to the wastewater flow. For the other method, the sample is collected by varying the volume of each individual aliquot proportional to the flow, while maintaining a constant time interval between the aliquots. Flow proportional samples can be collected directly with an automatic sampler that is connected to a compatible flow measuring device. An automatic sampler can also be used to collect discrete samples.

**Integrated (discharge-weighted) samples:** For certain purposes, the information needed is best provided by analyzing mixtures of grab samples collected from different points simultaneously, or as nearly so as possible, using discharge-weighted methods such as equal-width increment (EWI) or equal discharge-increment (EDI) procedures and equipment. An example of the need for integrated sampling occurs in a river or stream that varies in composition across its width and depth. To evaluate average composition or total loading, use a mixture of samples representing various points in the cross-section, in proportion to their relative flows. The need for integrated samples also may exist if combined treatment is proposed for several separate wastewater streams, the interaction of which may have a significant effect on treatability or even on composition. Mathematical prediction of the interactions among chemical components may be inaccurate or impossible and testing a suitable integrated sample may provide useful information. Both lakes and reservoirs show spatial variations of composition (depth and horizontal location). However, there are conditions under which neither total nor average results are especially useful, but local variations are more important. In such cases, examine samples separately (i.e., do not integrate them). Preparation of integrated samples usually requires equipment designed to collect sample water uniformly across the depth profile. Knowledge of the volume, movement, and composition of the various parts of the water being sampled usually is required. Collecting integrated samples is a complicated and specialized process that must be described in a sampling plan.

### 3.3 Characteristics of wastewater

The characteristics of wastewater can be classified as

1. Physical characteristics

2. Chemical characteristics
3. Biological characteristics

### 3.3.1 Physical characteristics of wastewater

**Colour:** Fresh domestic sewage is grey, with the passage of time as putrefaction starts, it begins to get black.

**Odour:** Normal fresh sewage has a musty odour which is normally not offensive, but as it starts to get stale, it begins to give offensive odour. Within 3-4hrs, all the oxygen present in the sewage gets exhausted and it starts emitting offensive odour of hydrogen sulphide gas & other sulphur compounds produced by anaerobic micro-organisms.

**Temperature:** Generally the temperature of wastewater is higher than that of the water supply due to addition of warm water from the households & from industries. When the wastewater flows in closed circuits, its temperature rises further. Average temperature of wastewater in India is around 20°C, which is quite close to the ideal temperature for the biological activities.

**Turbidity:** It is a measure of light-emitting properties of wastewater & turbidity test is used to indicate the quality of waste discharges w.r.t colloidal matters. The turbidity depends upon the strength of the sewage.

**Solid content:** Sewage normally contains 99.9% of water & 0.1% of solids. Total solids in wastewater exist in 3 forms:

1. Suspended solids
2. Dissolved solids
3. Colloidal Solids

### 3.3.2 Chemical characteristics of wastewater

**pH value:** The test for pH value of wastewater is carried out to determine whether it is acidic or alkaline. A high concentration of either an acid or alkali in wastewater is indicative of industrial wastes.

**Chloride content:** Chloride in natural water result from the leaching of chloride containing rocks & soils with which the water comes in contact. Chlorides found in domestic sewage is derived from kitchen wastes, human faeces & urinary discharges.

**Nitrogen Contents:** Nitrogen appears as

1. Ammonia Nitrogen or Free Ammonia: It is the very first stage of decomposition of organic matter. It exists in aqueous solution as either ammonium ion or ammonia depending upon the pH.
2. Organic Nitrogen: It is determined by Kjeldahl method. The sum of organic & ammonia nitrogen is called Total Kjeldahl nitrogen
3. Albuminoid Nitrogen: The quantity of nitrogen present in wastewater before the decomposition of organic matter is started. It indicates the amount of under composed nitrogenous material in the wastewater.
4. Nitrites Nitrogen: Nitrites indicate the presence of partly decomposed organic matter.
5. Nitrates Nitrogen: Nitrates indicate the presence of fully oxidized organic matter.

**Fats, grease & oils:** It is mainly contributed from kitchen wastes like butter, vegetable oils & fats. It is also discharge from industries like garages, workshops, factories etc. They interfere with biological action & cause maintenance problems.

**Surfactants:** It comes primarily from synthetic detergents. They are discharge from bathrooms, kitchens, washing machines etc.

**Phenols, pesticides & agricultural chemicals:** Phenols are found in industrial wastewater, if it is directly discharged into the rivers it causes serious taste problems in drinking water. Pesticides, agricultural chemicals result from surface runoff from agricultural, vacant, park lands.

**Toxic Compounds:** Copper, lead, silver, chromium, arsenic, boron (Toxic cations), Cyanides, chromates (Toxic anions) etc results from industrial wastewaters.

**Sulphates, Sulphides and H<sub>2</sub>S gas:** Sulphates & sulphides are formed due to decomposition of various sulphur containing substances present in wastewater. Anaerobic bacteria chemically reduce sulphates to sulphides and to H<sub>2</sub>S.

**Other gases:** carbon-di-oxide, methane, Hydrogen sulphide, ammonia, nitrogen, oxygen are the common gases found in untreated wastewater.

**Oxygen Consumed:** It is the oxygen required for the oxidation of carbonaceous matter.

**Dissolved Oxygen:** It is the amount of oxygen in the dissolved state in the wastewater.

Wastewater generally does not have DO, its presence in untreated wastewater indicated that the wastewater is fresh.

### 3.3.3 Biological characteristics of wastewater

The biological characteristics of sewage are related to the presence of micro-organisms.

1. Aquatic plant
2. Aquatic animals
3. Aquatic bacteria and viruses

**Anaerobic processes:** Decomposition of organic matter is called putrefaction & the result is called liquefaction as the solid organic matter is dissolved by enzymes. Anaerobic bacteria oxidize organic matter utilizing electron acceptors other than oxygen. In carrying out their metabolic process they produce CO<sub>2</sub>, H<sub>2</sub>O, H<sub>2</sub>S, CH<sub>4</sub>, NH<sub>3</sub>, N<sub>2</sub>, reduced organics & more bacteria. Treatment units which work on putrefaction alone are septic tanks, imhoff tanks and sludge digestion tanks.

**Aerobic Processes:** The work of the aerobic bacteria i.e. combination with oxygen is called oxidation. Aerobic bacteria utilize free oxygen as an electron acceptor. The end products of aerobic activity are CO<sub>2</sub>, H<sub>2</sub>O, SO<sub>4</sub>, NO<sub>3</sub>, NH<sub>3</sub> and more bacteria.

Though each of the above two processes work in opposite direction the former by splitting up & the latter by building up, there is co-ordination between two. In the first stage, the anaerobic bacteria decompose complex organic matter into simple organic compounds while in the second stage; the aerobic bacteria oxidize them to form stable compounds.

### 3.4 Flow diagram of Municipal wastewater treatment plant

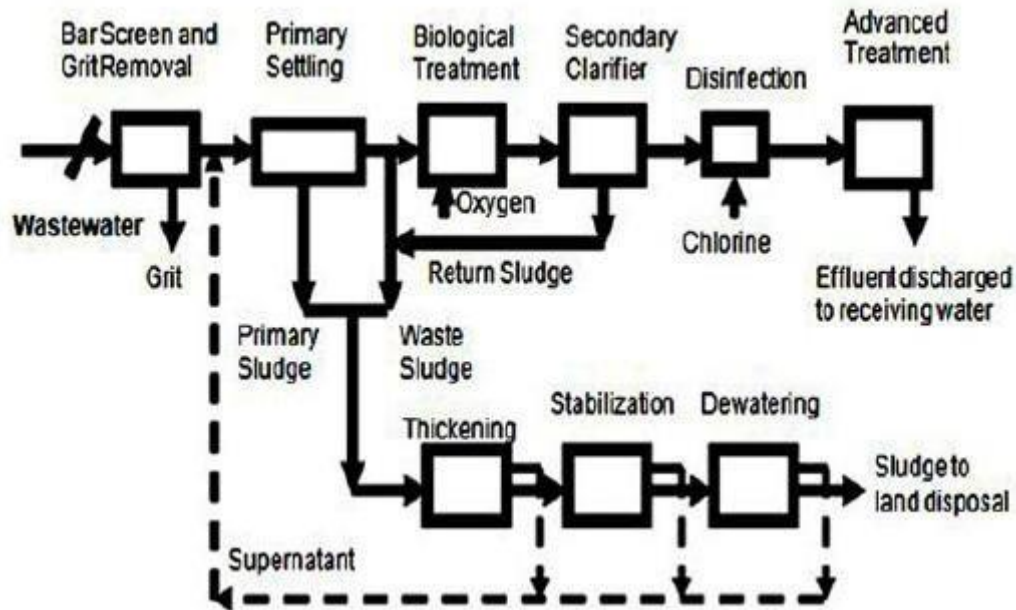

The influent or wastewater collected from residences or industries are first subjected to **Screening** process to remove the floating matters present in the sewage. The water which comes out of screening tanks is passed through the **Grit chambers** or **Detritus tanks** to remove the grits or sand particles. Then effluent which comes out of grit chamber is subjected to **Primary Sedimentation tanks** in order to remove the large suspended organic solids which is achieved by settling process where water is allowed to flow in slower rate, then heavy denser particles settles down at the bottom of the tank. The settled organic particles at the bottom of the primary sedimentation tanks is called **primary sludge**. The effluent which comes out of the primary settling tank is subjected to **Biological treatment or Secondary treatment** where, decomposition of organic matter takes place by aerobic bacteria with the supply of oxygen. Then stabilized organic particles along with the water is passed through the **Secondary clarifier** where the stabilized organic particles settle at the bottom of the tank. The sludge which is settled at the bottom of the tank is again recirculated back and mixed with effluent which comes out of primary sedimentation tank which is part of **Activated Sludge Process** and remaining sludge is mixed with primary sludge and then subjected to **Sludge digestion process**. In sludge digestion process, wastewater is first subjected to **Thickening**, where number of solid sludge particles are increased by separating from liquid. The liquid which rests over the solid sludge particles are removed out is called as supernatant. The solid sludge which consists of moisture content is removed out in **Dewatering process**. The dry form of sludge is used as manure for improving the fertility of soil. The effluent which comes out of secondary clarifier is fed into disinfection tank where chlorine is added to the wastewater to kill germs and pathogenic bacteria present in the water. Then water which comes out of disinfection tank containing germs are removed out in final or advanced or tertiary treatment process after that, the water can be directly discharged to nearby water courses.

**Treatment process as a whole classified into 4 types**

- 1) Preliminary treatment process
- 2) Primary treatment process
- 3) Secondary or Biological treatment process
- 4) Tertiary or final or advanced treatment process

**341 Preliminary treatment process:** This treatment process consists of separating the floating materials like dead animals, tree branches, papers, pieces of rags or wood etc., present in the sewage and also to remove heavy settleable inorganic solids. This process also helps in removing oil and grease particles present in the sewage. This process reduces the BOD of wastewater by about 15 to 30%.

The units used in preliminary process are

- a) **Screening** - For removal of floating matters like papers, rags, pieces of clothes etc.
- b) **Grit chambers or Detritus tank** – For removal of grits and sand particles.
- c) **Skimming tanks** – For removal of oil and grease particles present in the sewage.

**342 Primary treatment process:** This treatment process consists of removing large suspended organic solids. This is usually achieved by **sedimentation process**. The liquid effluent from primary treatment process consists of large amount of suspended organic matters having BOD of 60% of original. The organic solids which are separated out in the sedimentation tank are often stabilized by anaerobic decomposition in a digestion tank. This residue is used for land fills or soil conditioners.

**343 Secondary treatment process:** This treatment process further treats the effluent which is coming out from primary sedimentation tanks. This treatment process is achieved by biological decomposition of organic matter which can be carried out either under aerobic or anaerobic condition.

Treatment process in which organic matter is decomposed by aerobic bacteria is called aerobic decomposition. Units which are used in this treatment process are

- a) **Filters** – Intermittent sand filters as well as trickling filters. Intermittent sand filters are used for treatment of wastewater by attaching microorganisms to the filter medium and treated water is collected in the underdrains at the bottom of sand filter and is transported to a line for further treatment or disposal. Trickling filters are used to remove organic matter from wastewater. Trickling filter is an aerobic treatment system that utilizes microorganisms attached to the medium to remove organic matter from wastewater.
- b) **Aeration tanks** – Wastewater is mixed with microbes in the aeration tank and oxygen is supplied. Microbes consume that supplied oxygen and decompose the organic matter present in the wastewater and thus water is cleaned.
- c) **Oxidation ponds** – Oxidation ponds are also known as stabilization ponds or lagoons. Within an oxidation pond heterotrophic bacteria degrade organic matter in the sewage which



results in production of cellular material and minerals. The production of these support the growth of algae in the oxidation pond.

d) **Aerated lagoons:** Aerated lagoons or aerated basins is a holding and treatment pond provided with artificial aeration to promote the biological decomposition of wastewater.

Treatment process in which organic matter is decomposed anaerobic bacteria is called **anaerobic decomposition**. Units which are used in this treatment process are,

a) **Anaerobic lagoons:** These are also called as manure lagoon which are man made earthen basins filled with animal waste that undergoes anaerobic decomposition and it will be converted into excellent manures.

b) **Septic tanks:** These are water-tight box made of concrete or fibre glass to separate solids and liquids by settling process.

c) **Imhoff tanks:** These types of tanks are used for reception and processing of sewage which is achieved by sedimentation along with anaerobic sludge digestion.

The effluent from the secondary biological treatment will usually contain a little BOD of 5 to 10% of original.

**344 Final or Advanced or Tertiary treatment process:** This process removes remaining organic load after secondary treatment and to kill pathogenic bacteria present in the sewage and this achieved by chlorination

### 3.5 Unit operations:

**351 Screening:** Screening is the first and essential step in the treatment of sewage. It consists of passing sewage through different sized screens to trap and remove comparatively large size of floating matters. If such floating matters are not removed they may damage pumps and mechanical equipments, and it will interfere with the satisfactory operation of the treatment units.

Screen is device with openings generally of uniform size for removing bigger suspended or floating matters in sewage. The screening element may consists of parallel bars, gratings or wire meshes or perforated plates and the openings may be of any shape, although generally they are circular or rectangular.

Screen should be situated preferably just before grit chambers, and they are housed in a chamber called screen chamber. These screens are always set in an inclined position with an angle of about 30° to 60° with vertical. This increases the effective screening surface by 40 to 100% and helps in preventing the excessive loss of head due to clogging.

#### Types of screens

Screens may classified as follows:

1) **According to size of openings** – coarse, medium and fine screens.

- 2) **According to shape of screens** – disc, band, drum, cage, wing and perforated plates.
- 3) **According to the condition of movement** – fixed and movable.
- 4) **According to the method of cleaning** – hand cleaned or mechanically.

**According to size of openings:**

**Coarse Screen:** These type of screens are also called as **Racks or Bar screens**. They have relatively larger openings ranging from 5cm to 10cm. They serve more as protecting devices in contrast to fine screens with function as treatment devices. Bar screens are usually hand cleaned.

**Medium Screens:** These type of screens have openings of 2cm to 5cm. These are mechanically raked units, and used before all pumps or treatment units such as stabilization ponds.

**Fine Screens:** These type of screens are mechanically cleaned devices using perforated plates or very closely spaced bars with clear openings of less than 2cm and they need continuous cleaning to prevent clogging.

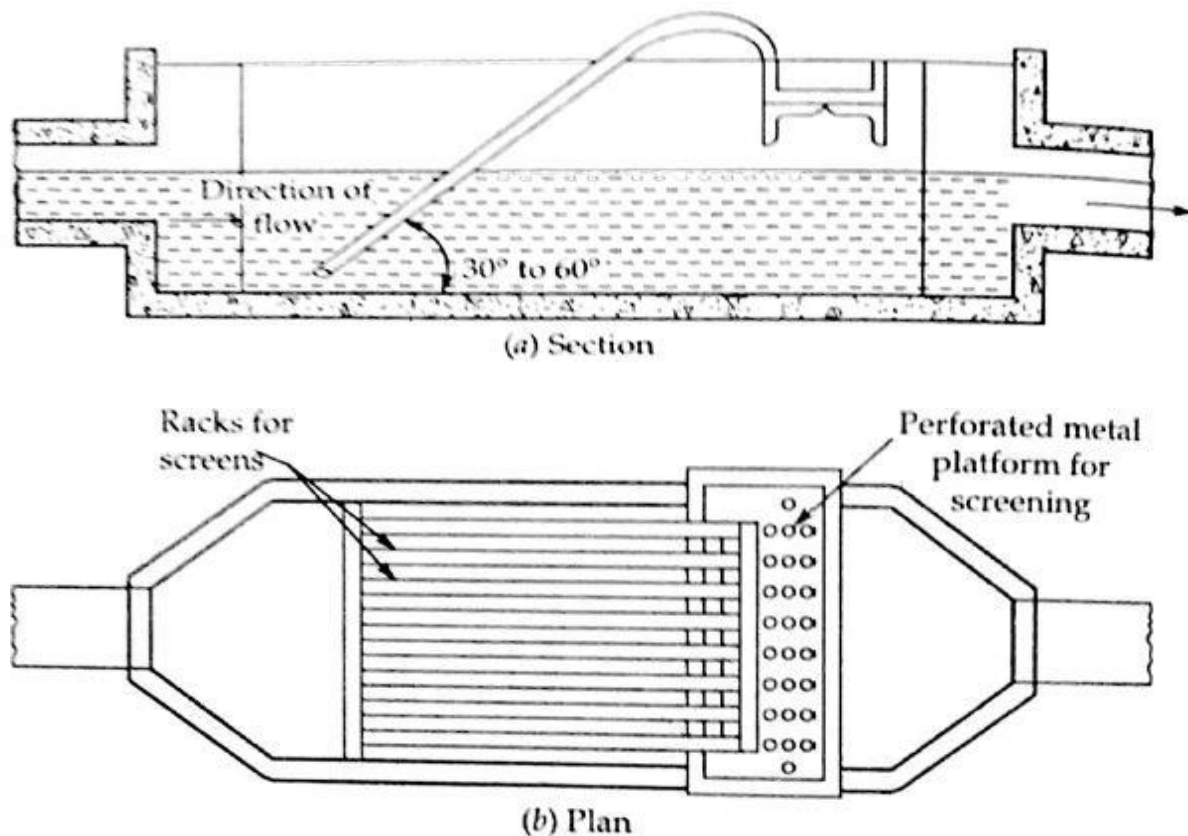

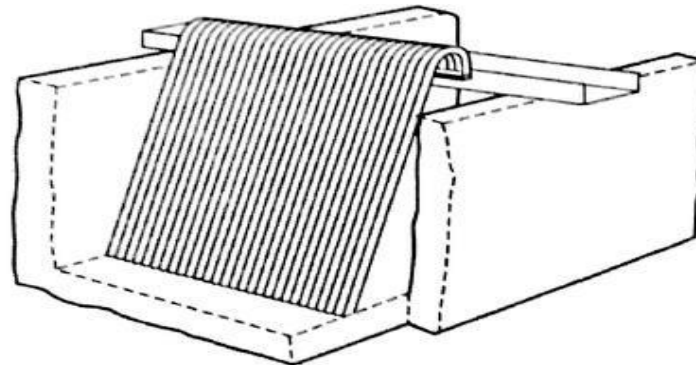

(c) Prospective view

Fig. 9.2. Fixed Bar type Hand Cleaned Coarse or Medium Screen or Rack.

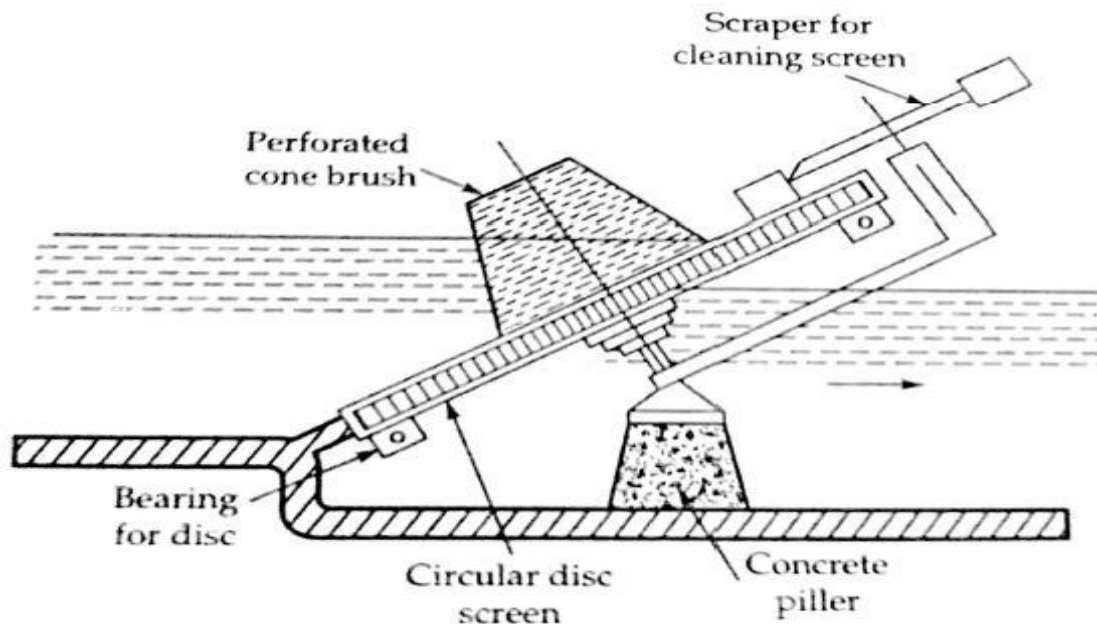

Fig. 9.3. Reinsch-Wurl screen (disc type fine screen).

**According to shape of screens:** These screens are usually fine screens and are available in different forms as mesh screen, band screen, perforated plate screen, wing screen, drum screen, disc screen, cage screen etc.

**According to the condition of movement:**

**Fixed screens** are permanently set in position and must be cleaned by **rakes** pulled between the bars.

**Movable screens** are stationary when in operation, but are lifted from the sewage for the purpose of cleaning.

Screen chambers are wide open channels which are provided with smooth entrance and exit. At its entry point, it should be narrow enough to keep the minimum approach velocity of flow

at a self-cleansing value and should be wide enough at its exit point to keep the maximum velocity from dislodging the accumulated slope.

**352 Grit chambers:** Grit includes sand and other heavy matters which are inert inorganic such as metal fragments, rags etc. If not removed in preliminary treatments, grit in primary settling tank can cause abnormal abrasive wear and tear on mechanical equipments and sludge pumps, can clog by deposition and can accumulate in sludge holding tanks and digesters. Therefore grit removal is necessary to protect the moving mechanical equipment and pump elements from abrasion.

Grit removal devices depends upon the differences in specific gravity between organic and inorganic solids to effect their separation.

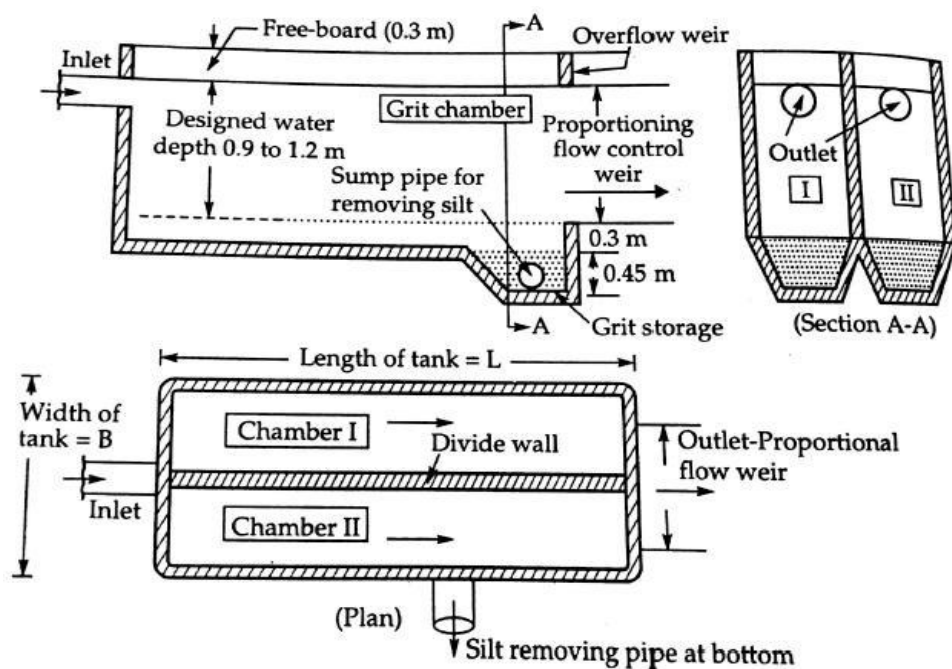

### Types of Grit chambers:

Grit chambers are of two types, mechanically cleaned and manually cleaned. Mechanically cleaned grit chambers are provided with mechanical equipment for collection and washing of grit chambers, which are operated either on a continuous or intermittent basis. Manually operated grit chambers should have sufficient capacity for storage of grits between the intervals of cleaning.

**Aerated Grit chambers:** An aerated grit chamber is a special form of grit chamber consisting of a standard spiral flow aeration tank provided with air diffusion tubes placed at one end of the tank at about 0.6 to 1m from the bottom. The heavier grit particles with their higher settling velocities drop down to the floor, where as lighter organic particles will remain in suspension and carried with the roll of spiral motion due to the diffused air and eventually carried out of the tank.

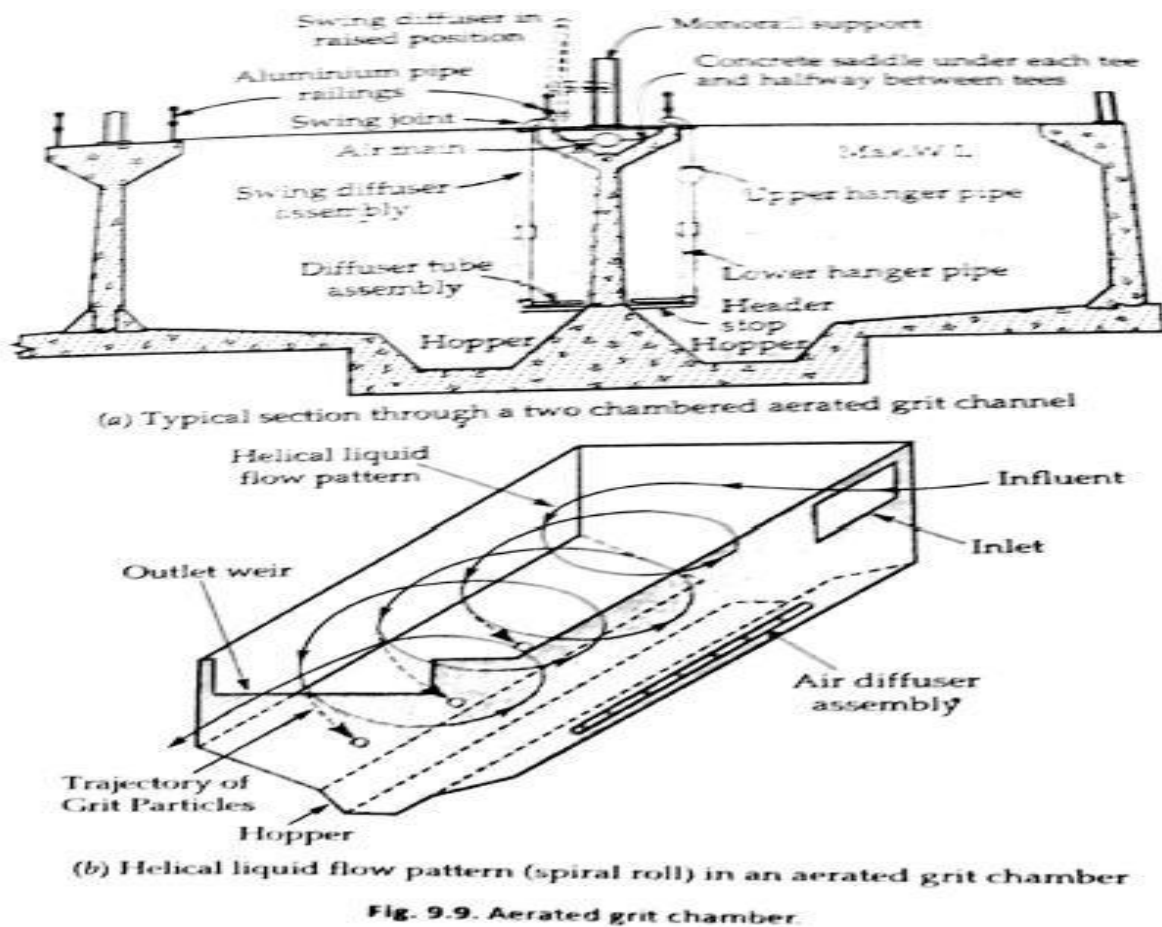

**353 Oil and Grease removal:** Oil and grease, if not removed, may create the following difficulties.

- 1) If sewage is being discharged into the water bodies for disposal, unsightly scum will be formed at the surface and foul odour is prevalent around the natural water bodies. The scum retards re-oxygenation and thus causes anaerobic conditions.
  - 2) They do not digest easily and therefore create problems in sludge digestion tanks.
  - 3) They promote clogging of filter material of the trickling filters.
  - 4) They affect the biological activities of the organisms and thus affect their smooth working.
- The oil and grease particles may be removed by floatation or settling as scum or sludge. Formation of scum is promoted by diffusing air through the sewage. The tank in which scum formation is promoted by air diffusion through the sewage is called **Skimming tanks**.

**Skimming tank:** Skimming tanks are narrow rectangular tanks having at least two longitudinal baffle walls interconnected. They are used to remove grease and fatty oils from the sewage. Air diffusers are provided at the bottom of the tank. Compressed air applied at the rate varying from 300 to 6000 m<sup>3</sup>/million litres of sewage agitates the sewage, which prevents settling of solids. Air tends to change the oil and grease to a soapy mixture. This mixture is carried to the surface by the air bubbles, sum of which are entrained in it and may be skimmed off.

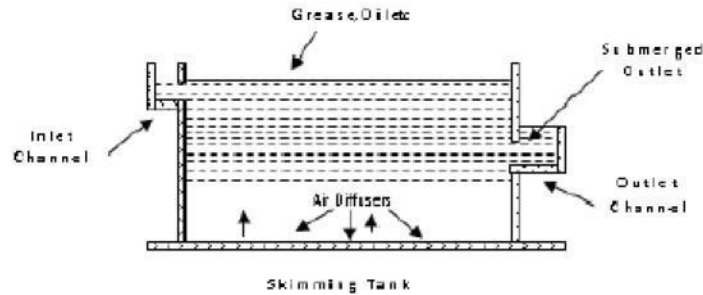

### 3.6 Trickling filters

Trickling filters are adopted for giving secondary treatment to sewage. It consists of tanks of coarser filtering medium, over which the sewage is allowed to sprinkle or trickled down by means of spray nozzles or rotary distributors. The percolating sewage is collected at the bottom of the tank through a well designed under drainage system. The purification of the sewage is brought about mainly by the aerobic bacteria, which form a bacterial film around the particles of the filtering medium. The action due to the mechanical straining of the filter bed is much less. In order to ensure the large scale growth of the aerobic bacteria, sufficient quantity of oxygen is supplied by providing suitable ventilation facilities in the body of the filter and also to some extent by the intermittent functioning of the filter.

The effluent obtained from the filter must be taken to the secondary clarifier for the settling out the organic matter, oxidized while passing down the filter.

#### Flow sheet of a trickling filter system

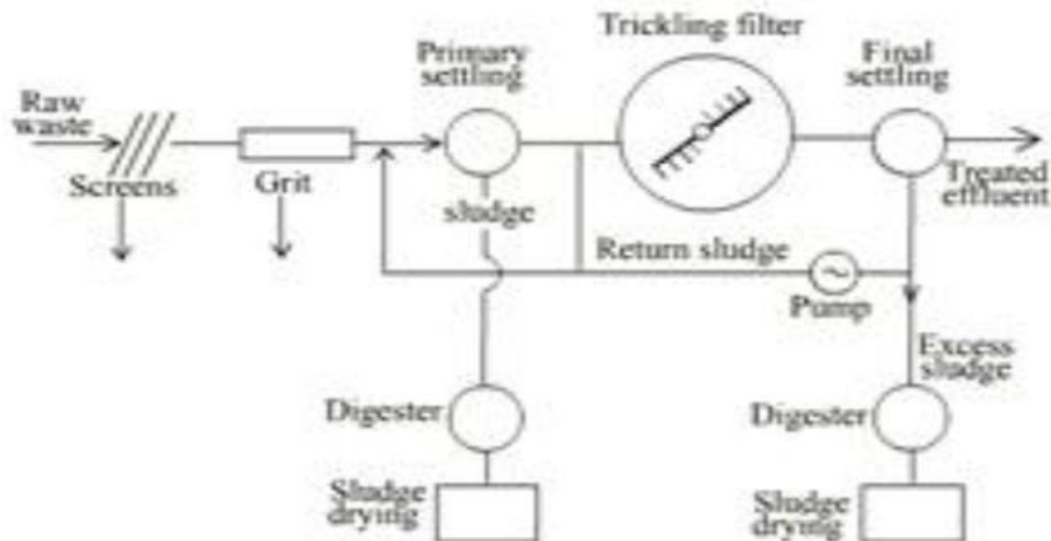

#### Construction and operation:

Trickling filter tanks are generally constructed above the ground. They may either be rectangular or more generally circular.

Rectangular filters are provided with a network of pipes having fixed nozzles, which spray the incoming sewage into the air, which then falls over the bed of the filter under the action of gravity.

Circular filter tanks are provided with rotary distributors having a number of distributing arms (generally 4 nos). These distributors rotate around a central support either

by an electric motor or more generally by the force of reaction on the sprays. Such self-propelled reaction type of distributors is now-a-days preferred and used. The rate of revolutions varies from 2 RPM for small distributors to  $< \frac{1}{2}$  RPM for large distributors. Two arms are used for taking low flows and all 4 arms are used in case of high flows. The distributing arms should remain about 15 to 20cm above the top surface of the filtering medium in the tank.

The application of the sewage to the filter is practically continuous with a rotary distributor, where as with spray nozzles, the filter is dosed for 3 to 5min and then rested for 5 to 10min before the next application. The dosing tanks are used in case of spray nozzles method.

The filtering medium consists of coarser materials like cubically broken stones or slag free from dust or small pieces of stones. The size varies from 25 to 75mm. The filtering material should be washed before it is placed in position and it should be unaffected by acidic action of sewage and should be sufficiently hard. Usually strong form rocks of granite or limestone may be used. The depth of filtering medium may vary from 2 to 3m. The walls of the filter tank should be provided with openings for the circulation of air through.

The under drainage system below the filter bed provides drainage and also ventilation of the sewage. These systems are made of vitrified clay blocks which are placed on a concrete thickness of 10 to 15cm thick and which is sloped gently at about 1 in 300 towards the main effluent rectangular channel. The main effluent channel may be provided adjoining the central column of the distributor. The depth and width of this central channel should be such that, maximum flow is carried below the level of the under drains.

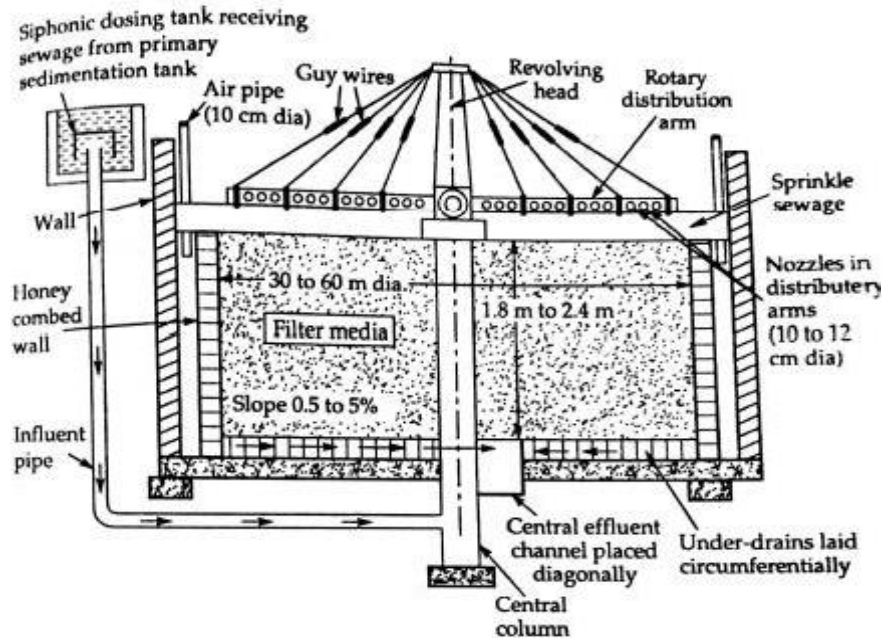

Fig. 9.18(a) Typical section of a conventional Circular-Trickling filter with Rotary distributors (vertical scale shown enlarged).

### Design of trickling filters

Design of trickling filters involves the design of diameter of the circular filter tank, its depth, the design of rotary distributor and under-drainage system.

1. Design of filter size is based upon the values of the filter loading – 22 to 44 million litres per hectare per day.

2. Organic loading rate – 900 to 2200 kg of BOD<sub>5</sub> per ha-m.

With an assumed value of organic loading, we can find out the total volume of the required filter by dividing the total BOD<sub>5</sub> of the sewage entering the filter per day in kg, by the assumed value of the organic loading. The organic loading can thus decide the volume of the filter.

The hydraulic loading rate on the other hand gives us the area of the filter required; when the total sewage volume entering the filter per day is divided by the hydraulic loading. Knowing the volume and the area of the cylindrical filter, we can easily find out its dia and depth.

### 3.7 Activated Sludge Process (ASP)

Activated sludge refers to biological treatment processes that use a suspended growth of organisms to remove BOD and suspended solids and process requires an aeration tank and a settling tank.

The activated sludge process was developed in England in 1914 and was so named because it involved the production of an activated mass of microorganisms capable of aerobically stabilizing the organic content of a waste. Activated sludge is probably the most versatile of the biological treatment processes capable of producing an effluent with any desired BOD. The process has thus found wide application among domestic wastewater and industrial wastewater treatment.

#### Flow diagram of Activated Sludge Process (ASP)

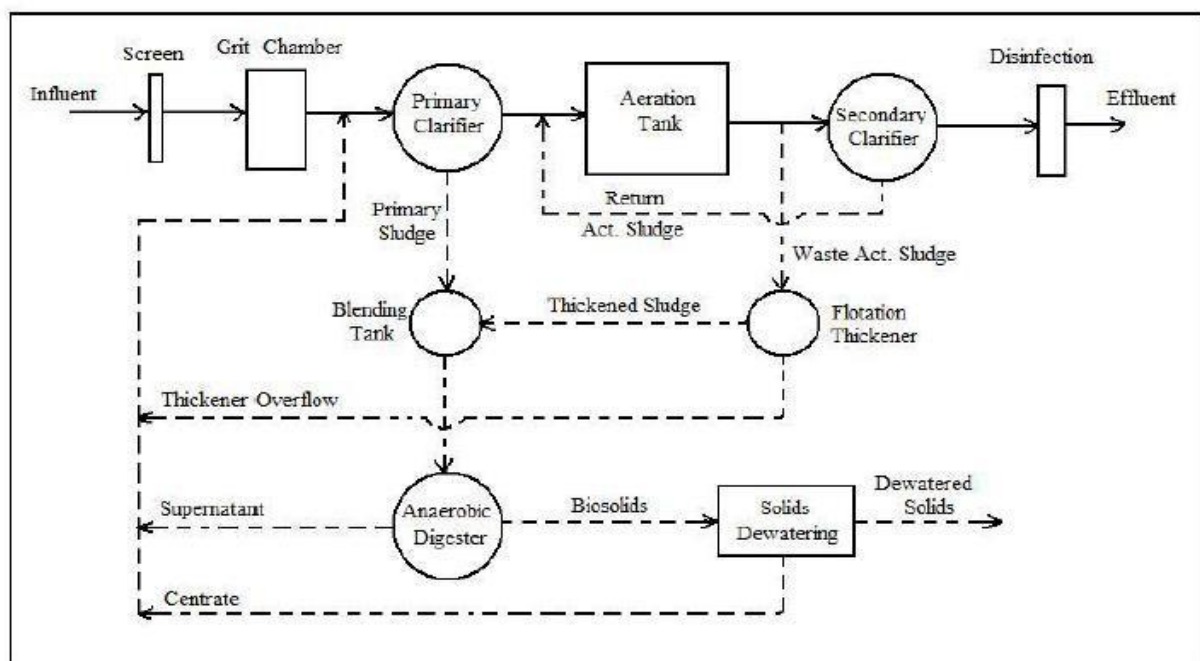

Primary effluent is mixed with return activated sludge to form mixed liquor. The mixed liquor is aerated for a specified length of time. During the aeration the activated sludge organisms use the available organic matter as food producing stable solids and more



organisms. The suspended solids produced by the process and the additional organisms become part of the activated sludge. The solids are then separated from the wastewater in the settling tank. The solids are returned to the influent of the aeration tank (return activated sludge). Periodically the excess solids and organisms are removed from the system (waste activated sludge). Failure to remove waste solids will result in poor performance and loss of solids out of the system over the settling tank effluent weir.

**Factors affecting ASP** There are a number of factors that affect the performance of an activated sludge treatment system. These include:

- temperature
- return rates
- amount of oxygen available
- amount of organic matter available
- pH
- waste rates
- aeration time
- wastewater toxicity

To obtain desired level of performance in an activated sludge system, a proper balance must be maintained between the amounts of food (organic matter), organisms (activated sludge) and oxygen (dissolved oxygen).

#### **Advantages of Sludge process**

1. It gives clear and non-putrescible effluent.
2. The process is free from offensive odour.
3. The process requires limited land area.
4. The sludge has commercial value.

#### **Disadvantages of Sludge process**

1. The process requires skilled personnel, careful supervision for design, operation and maintenance.
2. It gives poor results for shock loads and fluctuations in the effluent
3. The volume of the sludge produced is large and difficulties arise during dewatering of sludge.
4. It requires more initial investment.

### **3.8 Sequential batch reactors**

The operation of an SBR is based on a fill-and-draw principle, which consists of five steps- fills, react, settle, draw, and idle. These steps can be altered for different operational applications.

**Fill:** During fill, the influent wastewater is added to the biomass that was left in the tank from the previous cycle. It may be either the raw wastewater or the primary effluent. The length of the fill period depends on the number of SBRs, the volume of the SBRs, and the nature of the

flow of the wastewater source, which can be intermittent or continuous. Depending upon the treatment objective, the fill may be static, mixed or aerated

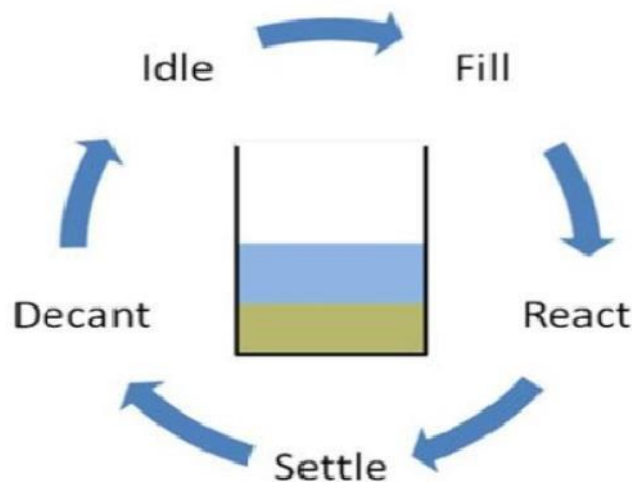

**React:** During the react phase, biomass consumes the substrate under controlled environmental conditions (aerobic, anaerobic) depending on wastewater treatment. During aerated react, the organic matter oxidation and nitrification take place. If the mixed reaction is applied, denitrification can be attained. Anaerobic conditions can also be achieved in the mixed react mode for phosphorus removal. The time dedicated to react can be as high as 50% or more of total cycle time

**Settle:** In the SBR, solids separation takes place under quiescent conditions (i.e., without inflow or outflow) in a tank, which may have a volume more than ten times that of the secondary clarifier used for conventional continuous-flow activated sludge plant. Quiescent conditions developed give rise to the better solid separation than that of conventional clarifiers. This phase normally lasts between 0.5 and 1.5 hours to avoid the solids blanket from floating due to gas build-up.

**Draw:** After the settle phase, the clarified supernatant is discharged from the reactor as effluent. The withdrawal mechanism may take one of several forms, including a pipe fixed at some predetermined level with the flow regulated by an automatic valve or a pump, or an adjustable or floating weir at or just beneath the liquid surface. In any case, the withdrawal mechanism should be designed and operated in a manner that prevents floating matter from being discharged. The time dedicated to draw can range from 5 to more than 30% of the total cycle time. The time in Draw, however, should not be overly extended because of possible problems with rising sludge.

**Idle:** The period between draw and fill is termed as idle. This phase is most necessary when SBR is used with a continuous wastewater flow. This time can be effectively used to waste sludge.

### 3.9 Moving bed bio reactors

The Moving Bed Biofilm Reactor (MBBR) is a highly effective biological treatment process that was developed on the basis of conventional activated sludge process and bio-filter process. It is a completely mixed and continuously operated Biofilm reactor, where the

biomass is grown on small carrier elements that have a little lighter density than water and are kept in movement along with a water stream inside the reactor. The movement inside a reactor can be caused by aeration in an aerobic reactor and by a mechanical stirrer in an anaerobic or anoxic reactor.

MBBR possesses many excellent traits such as high biomass, high COD loading, strong tolerance to loading impact, relatively smaller reactor and no sludge bulking problem. There are presently more than 400 large-scale wastewater treatment plants based on this process in operation in 22 different countries all over the world. During the past decade it has been successfully used for the treatment of many industrial effluents including pulp and paper industry waste, poultry processing wastewater, cheese factory wastes, refinery and slaughter house waste, phenolic wastewater, dairy wastewater and municipal wastewater. Recently, Moving Bed Biofilm Reactor (MBBR) has brought increasing research interest in practice for removal of biodegradable organic matter and its application has undergone various degrees of modification and development. Moreover, as the carrier using in the MBBR is playing a crucial role in system performance, choosing the most efficient carrier could enhance the MBBR performance. Hence, scientists have been looking for an appropriate carrier which is not costly and has a suitable surface for microbial growth. The main aim of this study is to evaluate a specific MBBR with polyethylene media as Biofilm support carrier in terms of OMs removal along with nutrient removal and microbial growth and activity.

#### Advantage of Moving Bed Biofilm Processes

1. Compact units with small size.
2. Increased treatment capacity.
3. Complete solids removal.
4. Improved settling characteristics.
5. Operation at higher suspended biomass
6. Concentrations resulting in long sludge retention times.
7. Enhanced process stability.

#### 3.10 Sludge digesters:

A sludge digestion tank is a RCC or steel tank of cylindrical shape with hopper bottom and is covered with fixed or floating type of roofs.

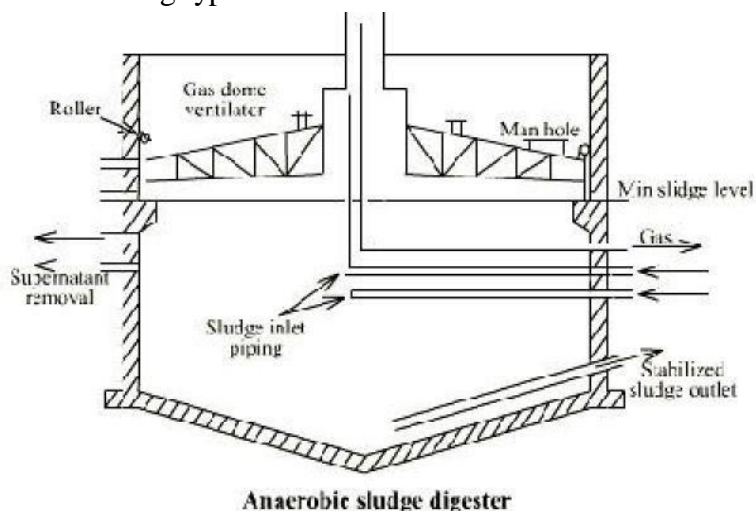

### Types of Anaerobic Digesters

The anaerobic digesters are of two types: standard rate and high rate. In the standard rate digestion process, the digester contents are usually unheated and unmixed. The digestion period may vary from 30 to 60 d. In a high rate digestion process, the digester contents are heated and completely mixed. The required detention period is 10 to 20 d.

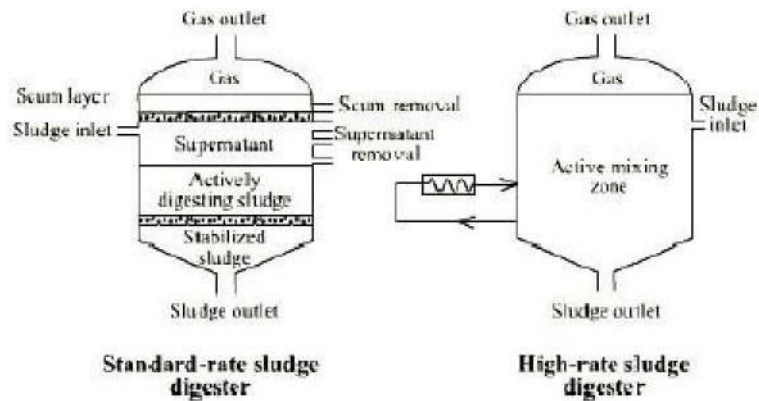

Often a combination of standard and high rate digestion is achieved in two-stage digestion. The second stage digester mainly separates the digested solids from the supernatant liquor: although additional digestion and gas recovery may also be achieved.

### 3.11 Recommended Questions

1. Define sampling. Explain the methods of sampling.
2. With flow diagram explain the municipal waste water treatment
3. Write a note on grit chamber and skimming tank.

### 3.12 Outcomes

- Evaluate degree of treatment and type of treatment for disposal, reuse and recycle.

### 3.13 Further Reading

1. [https://www.researchgate.net/publication/298346182\\_Biological\\_Treatment\\_Processes\\_Suspended\\_Growth\\_vs\\_Attached\\_Growth](https://www.researchgate.net/publication/298346182_Biological_Treatment_Processes_Suspended_Growth_vs_Attached_Growth)
2. <https://www.slideshare.net/jshrikant/sludge-management-and-sludge-digesters>
3. [https://www.dsd.gov.hk/rdforum/2014/ppt/Presentation\\_\(B4-1\).pdf](https://www.dsd.gov.hk/rdforum/2014/ppt/Presentation_(B4-1).pdf)
4. [https://www.mae.gov.nl.ca/waterres/training/aww/08\\_susheel\\_sequencing\\_batch\\_reactors\\_in\\_wastewater\\_treatment.pdf](https://www.mae.gov.nl.ca/waterres/training/aww/08_susheel_sequencing_batch_reactors_in_wastewater_treatment.pdf)

## Module – 4

### Structure

- 4.0 Introduction
- 4.1 Objectives
- 4.2 Difference between domestic and industrial waste water
- 4.3 Methods of industrial waste water treatment
- 4.4 Removal of organic
- 4.5 Inorganic and colloidal solids
- 4.6 Combined treatment methods
- 4.7 Feasibility study for combined treatment
- 4.8 Recommended questions
- 4.9 Outcomes
- 4.10 Further Reading

### 4.0 Introduction

Waste water characteristics, sampling, significance and techniques, physical, chemical and biological characteristics, flow diagram for municipal waste water treatment, unit operations; screens, grit chambers, skimming tanks, equalization tanks

Suspended growth and fixed film bio process, design of trickling filters, activated sludge process, sequential batch reactors, moving bed bio reactors, sludge digesters.

### 4.1 Objectives

- Understand and design different unit operations involved in conventional and biological treatment process.

### 4.2 Difference between Domestic and Industrial wastewater

Domestic sewage consists of liquid waste originating from bathrooms, water closets, kitchen sinks, wash basins etc of residential, commercial or institutions buildings. For example, apartments, hotels, hospitals, shopping mall etc

Industrial wastewater consists of wastes originating from the industrial processes of various industries such as paper manufacture, textile, sugar, brewing, dyeing etc. The quality of industrial wastewater depends largely upon the type of industry & the chemicals used in their process water. Sometimes, they may be very foul & may require extensive treatment before being disposed off in public sewage

Industrial waster as pointed out above, usually contains several chemical pollutants & toxic substances in too large proportions. The characteristics of the produced wastewater will usually vary from industry to industry & also vary from process to process even in the same industry, such industrial waster cannot always be treated easily by the normal methods of treating domestic wastewater & certain specially designed methods are sequence of methods may be necessary. The normal biological treatment methods for sewage are dependent up on the bacterial activity within the sewage, & as the toxic chemicals present in the industrial wastewater may hinder or destroy the bacterial activity. Therefore these normal methods may not be sufficient unless modify &/or supplemented by additional techniques.

### **Effect of effluent discharge on streams**

If the industrial waste water is discharged into streams, it causes depletion of DO of the stream. This is due to the settlement of the suspended substances and subsequent decomposition of the same in anaerobic condition. The alkalinity and toxic substances like sulphides & chromium affects the aquatic life and also interferes with the biological treatment processes. Some of the dyes are also found to be toxic. The color often renders the water unfit for use for side. The presence of sulphides makes the waste corrosive particularly to concrete structures. All treatment plants should be planned giving serious consideration for the reduction of waste volume & strength, through process of chemical substitution, chemical recovery & recycling of water. The pollution load from a textile, mill is dealt with operations like segregation, neutralization, equalization, chemical ppt, chemical oxidation & biological oxidation. Several chemicals are used to reduce the BOD by chemical coagulation such as alum, ferric sulphate, ferrous sulphate & ferric chloride, lime or  $H_2SO_4$  is used to adjust pH in this process. The dye waste may be economically treated by biological methods prior equalization, neutralization & chemical oxidation.

The industrial waste when discharged into sewer not only chokes the sewer due to the deposition of solids but also reduces the cross section of the sewer arising out of the lime encrustation.

Chromium compounds in excess of 10-20mg disrupt the operation of the trickling filter. Sulphides are also toxic to the micro organisms are removed along with the sludge. The sludge is dried over sand drying beds and can be used as good manure. Chemical coagulation (Alum, ferric chloride, and ferrous sulphate) with or without prior neutralization followed by biological treatment is necessary for better quality of effluent.

## **4.3 Methods of Industrial Waste Water Treatment;**

### **4.3.1 Volume reduction**

In general the first step in minimizing the effects of industrial wastes on relieving streams and treatment plants is to reduce the volume of such wastes. This may be accomplished by

1. Classification of wastes
2. Conservation of waste water
3. Change in production to decrease wastes.
4. Re- using both industrial & municipal effluent as raw water supplies.
5. Elimination of Batch or Slug Discharge of Process Wastes

### **Classification of wastes**

If wastes are classified so that manufacturing process waters are separated from cooling waters, the volume of water requiring intensive treatment may be reduced considerably. Sometimes it is possible to classify & separate the process waters themselves, so that only the most polluted once are treated & the relatively uncontaminated are discharge without treatment.

The 3 main classes of wastes are

a) Wastes from manufacturing process

These include waters used in forming paper, discharge from plating solutions in metal

fabrication those discharge from washing of milk cans in dairy plants etc.

b) Waters used as cooling agents in industrial process

The volume of these wastes varies from one industry to another. Although cooling water can be become contaminated by small leaks, corrosion products or the effect of heat, these wastes contain little, if any organic matter & are classed as non pollution.

c) Wastes from sanitary uses

The volume depends on many factors including size of the plant, amount of waste produce materials washed from the floors & the degree of cleanliness require & number of workers in the unit.

Unfortunately, in most old plants process, cooling & sanitary waste water are mixed in one pipeline & many industries are paying little attention to segregating wastes to avoid stream pollution.

### **Conservation of waste water**

Water conserve is water saved. Conservation begins when an industry changes from an open to a closed system. For example, a paper mill which recycles while water (water passing through a wire screen upon which paper is formed) & thus reduces the volume of waste waters it uses, is practicing water conservation.

Concentrated recycled wastewater is often treated at the end of their period of usefulness, since usually it is impractical & uneconomical to treat the waste waters as a complete each cycle. The savings are twofold i.e., both water cost & waste treatment cost are lowered.

One large textile mill reduced its water consumption by 50 % during a municipal water shortage, without any drop in production. It was observed that despite the savings to the mill, water usage returned to its original level one the shortage was over. This further illustrates the cheapness of water in the public mind.

Steel mills reuse cooling water to quench & coal processors reuse water to remove dirt & other non combustible materials from coal.

Introduction of conservation practices requires a complete engineering survey of existing water views & an inventory of all plant operations using water & producing wastes, so as to develop an accurate balance for peak & average operating conditions.

### **Change in production to decrease wastes**

This is an effective method of controlling the volume of wastes but at the same time it is very hard to persuade the industry to change their operations just to eliminate wastes as this may involve additional costs. However, the engineer can point out that reduction in the amount of Sodium sulphites used in dyeing, sodium cyanide used in plating and other chemical used directly in production has resulted in both reduction of wastes & saving of money.

Several other measures that can be used to reduce wastes include improved process control, improved equipment design, use of different or better quality raw materials, good housekeeping & preventive maintenance.

### **Reusing both industrial & municipal effluents as raw water supplies**

Practiced mainly in areas where water is scarce and/or expensive, this is proving a popular and economical method of conservation: of all the sources of water available to Industry,

Sewage plant effluent is the most reliable at all seasons of the year and the only one that is actually increasing in quantity and improving in quality.

Many industries and cities hesitate to reuse effluents for raw water supply. Certain technical problems such as hardness, color and aesthetic reluctance to accept the effluents as a potential source of water for any purpose. Also treatment plants are subject to shutdown and sudden discharges, both of which may make the supply undependable or of variable quality. However, as the cost of importing a raw water supply increase, it would seem logical to re-use Waste- treatment plant effluents to increase the present water supply by replenishing the ground water. The ever-available treatment plant effluent can produce a low cost steady water source through ground water recharge. Re-use of sewage effluent will reduce the quantity of pollution discharged by the municipality

### **Elimination of Batch or Slug Discharge of Process Wastes**

If the waste is discharged in a short period of time, it is usually referred to as a slug discharge. This type of waste, because of its concentrated contaminants and/or surge in volume, can be troublesome to both treatment plants and receiving streams.

There are at least two methods of reducing the effects of these discharges:

1. The-manufacturing firm alters its practice so as to increase the frequency and lessen the magnitude of Batch discharges.
2. Slug Wastes are retained in holding basins from which they are allowed to Flow continuously and uniformly over an extended (usually 24-hour) period.

### **4.3.2 Strength Reduction**

Waste Strength reduction is the second major objective for an industrial plant concerned with waste treatment. The strength of wastes may be reduced by

1. Process Changes
2. Equipment Modifications
3. Segregation of Wastes
4. Equalization of Wastes
5. By-Product Recovery
6. Proportioning of Waste sand
7. Monitoring Waste Streams

### **Process Changes**

In reducing the strength of wastes through process changes, the sanitary engineer is concerned with wastes that are most troublesome from a pollution standpoint.

### **Equipment Modification**

Changes in equipment can effect a reduction in the strength of the waste, usually by reducing the amounts of contaminants entering the waste stream. An outstanding example of waste strength reduction occurred in the dairy industry. The new cans were constructed with smooth necks so that they could be drained faster and more completely. This prevented a large amount of milk waste from entering streams and sewage plants.

### **Segregation of Wastes**

---



Segregation of Wastes reduces the strength and/or the difficulty of treating the final waste from industrial plant. It usually results in two wastes: one strong and small in volume and the other weaker with almost the same volume as the original unsegregated waste. The small-volume strong waste can then be handled with methods specific to the problem it presents. In terms of volume reduction alone, segregation of cooling waters and storm waters from process waste will mean a saving in the size of the final treatment plant.

### **Equalization of Wastes**

Plants, which have many products, from a diversity of processes, prefer to equalize their wastes. This requires holding wastes for a certain period of time, depending on the time taken for the repetitive process in the plant. For example, if a manufactured item requires a series of operations that take eight hours, the plant needs an equalization basin designed to hold the wastes for that eight hours period. The effluent from an equalization basin is much more consistent in its characteristics than each separate influent to that same basin.

Stabilization of pH and B.O.D and settling of Solids and Heavy Metals are among the objectives of equalization. Stable effluents are treated more easily and efficiently, than unstable ones by industrial and municipal treatment plants.

### **By-Product Recovery**

All wastes contain by products, the exhausted materials used in the process. Since some wastes are very difficult to treat at low cost, it is advisable for the Industrial Management concerned to consider the possibility of building a recovery plant which will produce a Marketable By-Product and at the same time solve a troublesome wastes problem.

### **Proportioning Wastes**

By Proportioning its discharge of concentrated wastes into the main sewer a plant can often reduce the strength of its total waste to the point where it will need a minimum of final treatment or will cause the least damage to the stream or treatment plant.

It may prove less costly to proportion one small but concentrated waste into the main flow. According to the rate of the main flow, than to equalize the entire waste of the plant in order to reduce the strength

### **Monitoring Waste Streams**

Accidental spills are often the sole cause of stream pollution or malfunctioning of treatment plants and these can be controlled, and often eliminated completely, if all significant sources of wastes are monitored.

#### **4.3.3 Neutralization**

Excessively acidic or alkaline wastes should not be discharged without treatment into a receiving stream. A stream is adversely affected by low or high pH values. This adverse condition is even more critical when sudden sludge of acids or alkalis are imposed upon the stream.

Acceptable Methods of Neutralization

1. Mixing wastes so that the net effect is a neutral pH.

2. Passing acid wastes through beds of limestone.
3. Mixing acid wastes with lime slurries.
4. Adding the proper proportions of concentrated solutions of caustic soda (NaOH) or soda ash (Na<sub>2</sub>CO<sub>3</sub>) to acid wastes.
5. Adding compressed CO<sub>2</sub> to alkaline wastes.
6. Adding sulphuric acid to alkaline wastes.

The material and method used should be selected on the basis of the overall cost, since material costs vary widely and equipment for utilizing various agents will differ with the method selected. The volume, kind and quality of acid or alkali to be neutralized are also factors in deciding which neutralizing agent to use.

#### 4.3.4 Equalization

Equalization is a method of retaining wastes in a basin so that the effluent discharged is fairly uniform in its characteristics (pH, color, turbidity, alkalinity, B.O.D etc). A secondary but significant effect is that of lowering the concentration of effluent contaminants. A retention pond serves to level out the effects of peak loadings on the plant while substantially lowering the BOD and suspended solids load to the aeration unit. Air is sometimes injected into these basins to provide:

1. Better mixing
2. Chemical oxidation of reduced compounds
3. Some degree of biological oxidation
4. Agitation to prevent suspended solids from settling.

The size and shape of the basins vary with the quantity of waste and the pattern of its discharge from the industry. The capacity should be adequate to hold and render homogeneous, all the wastes from the plant. Almost all industrial plants operate on a cycle basis; thus if the cycle operations is repeated for every two hours, an equalization tank which can hold a two -hour flow will usually be sufficient.

The mere holding of waste, however is not sufficient to equalizing it. Each unit volume of waste discharged must be adequately mixed with other unit volumes of waste discharged many hours previously.

This mixing may be brought about in the following ways:

1. Proper distribution and baffling: Proper distribution and baffling is the most economical, though usually least efficient method of mixing. Still this method is sufficient for many plants. Horizontal distribution of the waste is achieved by using either several inlet pipes, spaced at regular intervals across the width of the tank. Over and under baffles are advisable when the tank is wide because they provide more efficient horizontal and vertical distribution
2. Mechanical agitation: Mechanical agitation eliminates most of the need for baffles and generally provides better mixing than baffle alone. This type of equipment is good not only for equalisation but also for dilution, oxidation, reduction or any other function in which one wants chemical compounds discharged to react with compounds discharged before or after them to produce a desired effect.
3. Aeration: Aeration of equalizing basins is the most efficient way to mix types of

waste, but it is also the most expensive. Aeration facilitates mixing and equalization of waste prevents or decreases accumulation of settled material in the tank and provides preliminary chemical oxidation of reduced compounds such as sulphur compounds. It is of special benefit in situations in which wastes have varying character and quantity excess of reduced compounds and some settleable suspended solids.

4. Combination of all three.

#### 4.3.5 Proportioning

Proportioning means the discharge of industrial wastes in proportion to the flow of municipal sewage in the sewers or to the stream flow in the receiving river. In most case sit is possible to combine equalization and proportion in the same basin. The effluent from the equalization basin is metered into the sewer or stream according to a predetermined schedule. The objective of proportioning in sewers is to keep constant the percentage of industrial wastes to domestic sewage flow entering the municipal sewage plant.

This procedure has several purposes:

1. To protect municipal sewage treatment using chemicals from being impaired by a sudden overdose of chemicals contained in the industrial waste.
2. To protect biological treatment devices from strong loads of industrial wastes which may inactivate the bacteria
3. To minimize fluctuations of sanitary standards in the treated effluent
4. The rate of flow of industrial waste varies from instant to instant, as does the flow of domestic sewage system. Therefore the industrial waste must be equalized and retained, then proportioned to the sewer or stream according to the volume of domestic sewage or stream flow

There are two general methods of discharging industrial waste in proportion to the flow of domestic sewage municipal plant.

**Manual control:** manual control is lower in initial cost but less accurate. It involves determining the flow pattern of domestic sewage for each day of the week over a period of months.

**Automatic control by electronics:** Automatic control of waste discharge to sewage according to sewage flow involves placing a metering device that registers the amount of flow at the most convenient main sewer connection. This device translates the rate of flow in the sewer to a recorder located near the plants holding tank. The pen on the recorder actuates either a mechanical or a pneumatic control system for opening or closing the diaphragm of the pump. There are many variations of automatic flow control systems. Although their initial cost is higher than manual control, they will usually return the investment many times by the savings in labour costs.

#### 4.4 Removal of organic solids

The removal of dissolved organic matter from waste waters is one of the most important tasks of an engineer. These solids are usually oxidized rapidly by microorganisms in the receiving stream, resulting in loss of dissolved oxygen and the accompanying the ill effects of deoxygenated water. They are difficult to remove because of the extensive detention time required in biological process and often expensive equipment required for

other methods. In general, biological methods have proved more effective since the microbes including bacteria and protozoa, consume the organic pollutants as food. They metabolize the biodegradable organics, converting them into carbon dioxide, water and energy for their growth and reproduction. To keep the microbe healthy and productive in their task of wastewater treatment, they must be provided with enough oxygen, adequate contact with the organic material in the effluent suitable temperatures and other favorable conditions. The design and operation of a biological treatment plant is accomplished with these factors in mind.

There are many varieties of biological treatments, each adopted to certain types of wastewaters and local environmental conditions such as temperature and soil type. Some specific processes for treating organic matter are

- (i) Lagoonin gin oxidation ponds.
- (ii) Trickling filter.
- (iii) Activated – sludge treatment
- (iv) Modification of the activated sludge process
- (v) Anaerobic digestion.
- (vi) High-Rate aerobic treatment
- (vii) Wet combustion
- (viii) Spray irrigation

**Lagooning:** Lagooning in oxidation ponds is a common means of both removing and oxidizing organic matter and wastewaters as well. The most commons type of lagoon used for treating wastewaters is facultative pond. In a facultative pond, which is generally about 2m (6ft) deep, both aerobic and anaerobic biochemical reactions take place

Raw wastewater enters the pond eliminating the need for primary treatment. Organic solids that settle to the bottom decompose anaerobically, producing such substances as methane, organic acids, ammonia, carbon dioxide and hydrogen sulfide. In the liquid above the sludge zone of the pond, incoming organics and the products of anaerobic microorganisms are stabilized by facultative bacteria as well as by aerobic microorganisms. Facultative bacteria can grow in either aerobic or anaerobic environments. The average sewage detention time in a facultative pond may be 60 days or more. Oxygen is added to the wastewater in the pond by wind action and mixing at the surface and from the day light metabolism of algae taking place. This oxygen supports the aerobic reactions. The mutually dependent relationship between the algae and bacteria in a stabilization pond is very important. Using energy from sunlight, the algae grow and multiply by consuming the carbon dioxide and other inorganic compounds released by the bacteria. The bacteria use both the oxygen released by the algae and the organics from the wastewater. Although the algae play an important role in the purification process in a lagoon, they can also cause a problem. When, they die, they impose a secondary organic loading on the pond. Another disadvantage is seasonal one algae are less effective in winter. Beside this, lagoons are used with increasing frequency in areas where land is readily available. The low construction, operational and maintenance cost and negligible energy costs offer distinct advantages for this natural purification system.

**Trickling filters:** The trickling filter is a type of fixed growth system. The microbes remain fixed or attached to a surface, while the wastewater flows over the surface to provide contact with the organics. Thus the trickling filter may be defined as a process by which biological units are coated with slime growths from the bacteria in the wastes. These growths adsorb and oxidize dissolved and colloidal organic matter from the wastes applied to them.

A trickling filter consists basically of a layer or bed of crushed rock about 2 m deep. It is usually circular in shape and may be built as large as 60 m in diameter. Crushed stones may be of granite and limestone or sometime other materials, such as plastic rings, may also be used, because plastic media are light weight, chemical resistant.

As the primary effluent trickles downward through the beds of stones, a biological slime of microbes develops on the surfaces of the rocks. The continuing flow of the wastewater over these fixed biological growths provides the needed contact between the microbes and the organics. The microbes in the thin slime layer adsorb the dissolved organics, thus removing oxygen – demanding substances from the wastewater. Air circulating through the void spaces in the bed of stones provides the needed oxygen for stabilization of the organics by the microbes.

### **Activated sludge treatment**

The activated sludge process is probably versatile and effective of all wastewater treatment processes. It is quite effective in the treatment of domestic sewage, as well as a few industrial wastes from large plants. The basic component of an activated sludge sewage treatment system includes an aeration tank and a secondary settling basin or clarifier. Primary effluent is mixed with settled solids that are recycled from the secondary clarifier and then introduced into the aeration tank. Compressed air is injected continuously into the mixture through porous diffusers located at the bottom of the tank along one side

In the aeration tank, microorganisms consume the dissolved organic pollutants as food and convert organic materials in wastewater to microbial biomass and CO<sub>2</sub> by using O<sub>2</sub> provided in the air compressor. The organic nitrogen is converted to ammonium ion or nitrate.

The aerobic microorganisms in the tank grow and multiply, forming an active suspension of biological solids called activated sludge. The combination of the activated sludge and wastewater in the aeration tank is called the *mixed liquor*. In basic or conventional activated sludge treatment system, a tank detention time of about 6h is required for through stabilization of most of the organics in the mixed liquor. After about 6h of aeration, the mixed liquor flows to the secondary or final clarifier, in which the activated sludge solids settle out by gravity.

**Modification of the activated sludge process:** Several modification of the conventional activated sludge process has been developed. The objective is to supply the maximum of air to the sludge when it is in optimum condition to oxidize adsorbed organic matter. In step aeration process, the sewage is introduced along the length of aeration tank in several steps; while the return sludge is introduced at the head. Such an arrangement results in the uniform air requirement along the entire length of tank. The process enables a large reduction in the size of aeration tank. There are two important distinctions between step aeration system and a conventional system. First, screened sewage is directed into the step aeration tank without

any primary setting. Second, the detention time or aeration period is about 30 h, whereas the conventional system's detention time is about 6h.

**Anaerobic digestion:** It is a process for oxidizing organic matter in closed vessels in the absence of air. The process has been highly successful in conditioning sewage sludge for final disposal. It is also effective in reducing the BOD of soluble organic liquid wastes such as yeast, slaughterhouse, dairy, and paper mill waste. Generally anaerobic processes are less effective than aerobic processes, mainly because of the small amount of energy that results when anaerobic bacteria oxidize organic matter. Anaerobic processes are therefore slow and require low daily loading and long detention periods. However, since little or no power need be added, operating cost is very low. Where liquid wastes volumes are small and contain no toxic matter and there are high percentages of readily oxidized dissolved organic matter, this process has definite advantages over aerobic system. The pH in the digester must be controlled to near the neutral point

**High-Rate aerobic treatment:** This process consists of comminution of the waste, long period (1-3 days), final settling of the sludge and return of the settled sludge to the aeration tank. There is no need for sludge digestion but the aeration system must be large enough to provide the required aeration period. The total oxidation process is particularly useful in small installations because it does not require a great deal of supervision.

**Wet combustion:** Wet combustion is the process of pumping organics laden waste water and air into a reactor vessel at elevated pressure. The organic functions undergo rapid oxidation, even though they are dissolved or suspended in the waste. This rapid oxidation gives off heat to the water by direct convection and the water flashes into a steam. Inorganic chemicals which are present in many industrial wastes can be recovered from the steam in a separate chamber.

**Spray irrigation:** Spray irrigation is an adaptation of the familiar method of watering agricultural crops by portable sprinkling irrigation system. Wastes are pumped through portable pipes to self actuated sprinkler heads. Light weight aluminium or galvanised piping, equipped with quick assembly pipe joints can be easily moved to areas to be irrigated and quickly assembled. Wastes are applied as a rain to the surface of the soil with the objective of applying the maximum amount that can be absorbed without surface runoff or damage to the cover crops.

#### 4.5 Removal inorganic dissolved solids

Little attention has been given to the removal of dissolved minerals from waste waters by waste treatment engineers, because minerals have been considered less polluting than organic matter and suspended solids. However, regarding the causes and effects of pollution, it is important to reduce the quantity of certain types of inorganic matter. Chloride, phosphates, nitrate and certain metals are examples of the significant inorganic dissolved solids. The various methods employed for removing inorganic matter are

- (i) Evaporation

- (ii) Electro dialysis
- (iii) Ion exchange
- (iv) Algae
- (v) Reverse osmosis
- (vi) Miscellaneous

**Evaporation:** This is a process of bringing wastewater to its boiling point and vaporizing pure water. The vapor is either used for power production, or condensed and used for heating, or simply wasted to the surrounding atmosphere. The minerals solids concentrate in the residue is reused either in production cycle or to be disposed of easily. Chrome, nickel, and copper plating wastes may be reclaimed from the rinse tank by evaporation in glass-lined equipment or other suitable evaporators, and the concentrated solution returned to the plating system. Efficiency of evaporation is directly related to heat-transfer rate expressed in British thermal units per hour (Btu/hr)-through the heating surface.

**Electro dialysis:** It is the separation of solute by means of their unequal diffusion through membranes. It is most useful in recovering pure solutions for reuse in manufacturing processes for e.g. caustic soda in textile industry. Electro dialysis work on the simple principle of passing a concentrated, impure caustic solution upward, counter current to a downstream water supply, from which it is separated by a semi-permeable membrane. The caustic soda permeates the membranes and goes into water more rapidly than the other impurities contained in the water. The quantity of NaOH diffusing through the membrane diaphragm depends upon the time, the area of the dialyzing surface, the mean concentration difference and the temperature.

Electro dialysis is an operation requiring very little operator attention and although its main role is to conserve raw materials and to reduce plant waste, at the same time it aids in waste treatment. With the introduction of acid resistant membranes, Electro dialysis has been used successfully in the recovery of sulphuric acid in the copper, stainless steel and other industries. Some operation can recover as much as the 70 to 75% of the acid, but recovery as little as 20% may be justifying the process. In Electro dialysis, the driving force of separation is natural diffusion because of concentration gradient. Electro dialysis is another form of dialysis in which the natural driving force is enhanced by the application of electrical energy. Electro-dialysis can achieve as much as 44 percent reduction in concentration of dissolved solids in industrial effluents.

**Algae:** The use of algae for removing minerals from waste water has been investigated. Although sedimentation and filtration do not remove any phosphorus, the algae actively growing in the ponds caused a reduction of about 42% of the phosphate content. Chlorella and Scenedesmus are most active algae in stabilized ponds; because they are very hardy.

**Reverse osmosis:** It is process for separating relatively pure water or some other solvent from a less pure solution. The solution is passed over the surface of a specific semi-permeable membrane at a pressure in excess of the effective osmotic pressure of the feed solution. The permeating liquid is collected as the product and the concentrated feed solution is generally discarded. The membrane must be (1) highly permeable to water (2) highly impermeable to

solutes (3) capable of withstanding the applied pressure without failure, (4) chemically inert, mechanically strong.

Reverse osmosis is an advanced unit operation in water treatment. Reverse osmosis membranes are capable of removing at least 90 percent of the dissolved solids in water as well as organics, bacteria and others impurities.

**Ion exchange:** Ion exchange is basically a process of exchanging certain undesirable cations and anions of the wastewater for sodium, hydrogen or other ions in resinous materials. The resins, both natural and artificial are commonly referred to as Zeolites.

#### **Miscellaneous methods:**

Chemical precipitation or coagulation has been used to remove some inorganic matter from wastewater.

Chemical oxidation consists of addition of chemicals like chlorine and ozone to reduce the BOD loading on the subsequent biological process or to reduce the substances like ammonia, cyanide etc.

Thermal reduction involves the burning and thereby oxidation of some refractory and toxic substances.

#### **Removal of colloidal solids**

A colloids particle is extremely small size (1-200 mill microns). These particles do not settle out on standing and cannot be removed by conventional physical treatment processes. Colloids are often responsible for a relatively high percentage of the color, turbidity, and BOD of certain industrial wastes. Thus it is important to remove colloids from wastewater before they can reach into streams.

Colloids exhibit Brownian movement that is the continuous, random movement of tiny solid particles in liquids or gases. This is caused by the impact of moving liquid or gas molecules pushing at the solid particles from all the side. They are essentially non-settleable because of their charge, small size and low particle weight. They are dialyzable through semi permeable membrane. Colloidal particle are generally electrical charged with respect to their surroundings. An electric current passing through a colloidal system causes the positive charges to migrate to the cathode and the negative one to the anode. Colloids exhibit Tyndall effect; that is the scattering of light from very small particles, as seen when a beam of sunlight passes through a dirty atmosphere. This gives bluish light. True solution shows no Tyndall effect, where as colloidal solutions do.

#### **Chemical Coagulation**

This is a process of destabilizing colloids, aggregating them and binding them together for sedimentation. It involves the formation of chemical flocs that absorb, entrap, or otherwise bring together, suspended matter that is so finally divided as to be colloidal. The chemicals most commonly used are: alum, copperas, Ferric Sulfate, Ferric Chloride. Ferric Chloride and chlorinated copper as a mixture of ferric sulfate and chloride. Aluminum sulfate appears to be more effective in coagulating carbonaceous wastes, while iron sulfates are more effective when a considerable quantity of proteins is present in the wastes



Coagulation by Neutralization of the Electrical Charges This can be performed by:

- Lowering of the zeta potential of the colloids. Zeta potential is the difference in electrical charge existing between the stable colloid and the dispersing medium
- Neutralizing the colloidal charge by flooding the medium with an excess of oppositely charged ions usually hydrous oxide colloids formed by reaction of the coagulant with ions in the water.

In this process, the coagulant colloids also become destabilized by the reaction with oppositely charged colloids and produce hydrous oxide, which is a floc-forming material.

From the stand point of electrical charges, there are two predominant types of colloid in wastewaters

- ✓ Colloids naturally present, including several proteins, starch, hemicelluloses, polypeptides and other substances, all possess negative charge.
- ✓ Colloids artificially produced by coagulants usually the hydroxides of iron and aluminium are mainly positively charged ions.

### **Combined treatment methods:**

#### **Merits:**

- ✓ Here the responsibility is placed with one owner, while at the same time, the cooperative spirit between industry & municipality increases, particularly if the division of costs is mutually satisfactory.
- ✓ Only one chief operator is required, whose sole obligation is the management of the treatment plant i.e he is not burdened by the miscellaneous duties often given to the industrial employee in charge of waste disposal & the chances of mismanagement and neglect which may result if industrial production men operate waste treatment plants, are eliminated.
- ✓ Since the operator of such a large treatment plant usually receives higher pay than separate domestic plant operators, better trained people are available.
- ✓ Even if identical equipment is required construction costs are less for a single plant than for 2 or more. Furthermore, municipalities can apply for state & or federal aid for plant construction, which private industry is not eligible to receive.
- ✓ The land required for plant construction & for disposal of waste products is obtained more easily by the municipality.
- ✓ Operating costs are lower, since more waste is treated at a lower rate per unit of volume.
- ✓ Possible cost advantages resulting from lower municipal financing cost & federal grants.
- ✓ Some wastes may add valuable nutrient for biological activity to counteract other industrial wastes that are nutrient deficient. Thus bacteria in the sewage are added to organic industrial wastes as seeding material. These micro organisms are vital to biological treatment. Also, acids from one industry may help to neutralize alkaline wastes from another industry.
- ✓ The treatment of all waste water generated in the community in a municipal plant, enables the municipality to assure a uniform level of treatment to all the users of the

river & even to increase the degree of treatment given to all waste water to the maximum level obtainable with technological advance.

**Demerits:**

- ✓ If an industrial waste water stream is discharged to municipal waste treatment system which has to been designed to handle it, the discharge may cause serious problem. It could disrupt the treatment processes affecting the performance and hence the treated effluent characteristics.
- ✓ The seriousness of the effect will depend on the characteristics of industrial waste streams, the size and design of municipal waste treatment system and standards for discharge recycle or reuse.
- ✓ Waste characteristics such as temperature, pH, organic content, toxicity and flow must be evaluated to determine the acceptability to municipal waste treatment system otherwise it will cause serious problems.
- ✓ Among many problems arising from combined treatment the most important is the character of the industrial waste water reaching the disposal plant.
- ✓ Because most sewage plants use some form of biological treatment, it is essential for satisfactory operation
  - As homogenous in composition and uniform in flow rate as possible and free from sudden dumping of the more deleterious industrial wastes
  - Not highly loaded with suspended matter
  - Free of excessive acidity or alkalinity and not high in content of chemicals that precipitate on neutralization or oxidation
  - Practically free of antiseptic materials and toxic trace metals
  - Low in potential sources of high BOD, such as carbohydrates, sugar, starch and cellulose
  - Low in oil and grease content.

**Feasibility study for combined treatment:**

Some of the important scientific factors associated with industrial waste treatment include the following.

**Type of municipal sewage treatment:** A secondary biological treatment plant if adequately sized can be utilized to treat a readily decomposable organic laden industrial waste. Typical examples include dairies, canneries, slaughterhouses and tanneries. However each of these wastes as well as other typical organic wastes, contain contaminants which can interfere with effective treatment when combined with domestic sewage. For example dairy wastes often turn acid extremely fast and lowered pH can affect biological oxidation, while tannery wastes contain chromium, sulfides and lime which are not compatible with normal sewage treatment. Proper pretreatment and plant operation however can remedy these problems. In some cases it has been shown that trickling filters can handle industrial waste with less upsets than activated sludge system.

**Characteristics of industrial waste:** When considering the treatment of the wastes from tissue paper mill, industry needs a municipal plant which concentrates its equipment units on the removal of the finely divided suspended solids area of waste treatment. It is of little benefit

to the tissue paper mill if the municipal plant possesses only a high rate trickling filter primarily designed for BOD removal.

The engineer must carry out a complete analysis of the industrial waste to ascertain its compatibility for treatment by varied possible method. Some analysis often overlooked by the sanitary engineer include the waste deoxygenation rate, ultimate oxygen demand, toxic chemicals & metals, temperature, grease content, refractory organic matter, phosphate & nitrates and other algae nutrients etc. These and other important characteristics of certain industrial wastes should signal the key to their eventual successful matter.

**Receiving stream water quality:** It is a foregone conclusion that a stream which must be maintained in a high water quality state requires the maximum offshore waste treatment. Generally this means a minimum of the equivalent to secondary treatment. Often the conventional biological treatment system will not adequately remove sufficient amounts of the contaminants. Sometimes specific treatment such as chemical precipitation followed by adsorption on activated carbon may remove more industrial contaminants than a secondary type trickling filter plant. Industry has inherited the moral if not the legal, obligation of treating its waste in a manner so as to maintain the highest possible quality water level in the receiving stream.

**Volume ratio of industrial to municipal waste:** A relatively small volume of industrial waste can usually be assimilated in a municipal sewage treatment system regardless of its contaminants. This fact does not always depend upon rational reasoning but is often based on results of the very fact that an attempt to handle the wastes is made. In other words municipal plant operators generally react optimistically towards small volumes of industrial wastes agree to try to treat them and end up accepting them with or without certain preconditions. When ratios are high industry usually builds its own treatment plant despite the potentially favorable economics or the potential compatibility for joint treatment.

**Economics of alternatives:** Industry tends to select the least costly alternative especially when other conditions are equal. Usually industry prefers to compare alternative system costs on the basis of total capital expenditures; the least expensive capital outlay is often preferred.

### **Discharge of raw, partially treated and completely treated wastes to streams**

The effect of waste water on the water environment may be physical, chemical and biological effect.

Physical effect includes increase in turbidity and suspended solids, addition of color, taste and odor producing substances, and formation of sludge banks on the beds and sides of the water bodies. Industrial wastes such as cooling waters from power stations, dyeing and printing wastes from textile industry, spent wash from alcohol distilleries etc raise the temperature of water in the receiving body and reduce the DO content in it. These conditions impart an aesthetically unacceptable appearance to the water, create an environment unsuitable for aquatic creatures such as fish, render it difficult to treat, and initiate the chain of chemical and biological effects.

Chemical effects include a drastic change in the pH value of the receiving water due to a discharge of acidic wastes such as mine drainages or alkaline wastes such as textile wastes. High chlorides renders the water unacceptable as a source of drinking water, high sulphates, under favorable circumstances tend to form hydrogen sulphide and produce malodorous condition, nitrates and phosphates encourage algal and other aquatic growths, toxic and inhibitory substances either wipe out the aquatic life or severely limit its growth and reduce the

available DO in the water. The DO may even become zero in the presence of a slug of oxygen-demanding wastewater.

Biological effects due to industrial wastes alone are not very serious because many of them do not contain pathogenic organisms that are present in domestic sewage. When industrial wastes are discharged in combination with domestic sewage, biological effects become significant although a large number of micro-organisms in the sewage are killed by unfavorable environmental conditions in the industrial waste. The physical and chemical effects have an adverse effect on the aquatic life, turbidity and suspended solids, along with color, cut-off penetration of sunlight into the water and reduce photosynthetic activity. Suspended solids can choke the gills of fish and kill them. Organic suspended solids settle to the bottom of the receiving body of water and in the presence of micro-organisms, decompose anaerobically. The products of anaerobic decomposition gradually diffuse to the upper layers of water and add to the total oxygen demand. Anions such as chlorides, sulphates add to the total dissolved solids content of the water and interfere with the metabolic process of micro-organisms. Nitrates and phosphates encourage enormous algal growth in the water.

#### **4.8 Recommended Questions:**

1. Explain how volume is reduced in industrial waste water treatment.
2. Explain how strength is reduced in industrial waste water treatment.
3. Write the merits and demerits of combined treatment method.
4. Explain the methods of removal of organics solids
5. Explain the methods of removal of inorganic solids

#### **4.9 Outcomes**

1. Identify waste streams and design the industrial waste water treatment plant.
2. Manage sewage and industrial effluent issues.

#### **4.10 Further Reading**

1. <https://www.sciencedirect.com/science/article/pii/B9780123724939500430>
2. [http://www.rtu.ac.in/RTU/wp-content/uploads/2015/06/ppt\\_industrial\\_treatment.pdf](http://www.rtu.ac.in/RTU/wp-content/uploads/2015/06/ppt_industrial_treatment.pdf)

## Module – 5

### Structure

- 5.0 Introduction
- 5.1 Objectives
- 5.2 Cotton and textile industry
- 5.3 Tanning industry
- 5.4 Cane sugar and distilleries
- 5.5 Dairy industry
- 5.6 Steel and cement industry
- 5.7 Paper and pulp industry
- 5.8 Pharmaceutical and food processing industry.
- 5.9 Recommended Questions
- 5.10 Outcomes
- 5.11 Further Reading

### 5.0 Introduction

The fibers used in the textile industry may be groups such as cotton, wool, synthetic etc. The characteristics of the waste from the mill depends on the type of fiber used, as different types of fibers go through different sequences of operations before the woven cloth is sent out of the mill. The pollutants in the waste water include the natural impurities in the fibers used and the processing chemicals.

### 5.1 Objectives

1. Understand and design different unit operations involved in conventional and biological treatment process.
2. Apply the principles of Industrial effluent treatment process for different industrial wastes.

### 5.2 Cotton and Textile Industry

#### Manufacturing process

An integrated cotton textile mill produces its own yarn from the raw cotton. Production of yarn from raw cotton includes steps like opening & cleaning picking, carding, and drawing spinning, winding & warping. All these sequences are dry operations and as such do not contribute to the liquid waste of the mill. The entire liquid waste from the textile mills comes from the following operation of slashing (sizing), scouring, desizing, bleaching, mercerizing, dyeing & finishing.

In slashing the yarn is strengthened by loading it with starch or other substances wastes originates from the sections due to spills & floor washings. The substitution of low BOD sizes (such as carboxy methyl cellulose) for the high BOD of the mill effluent by 40 to 90%. After slashing, the yarn goes for weaving. The prepared cloth now requires scouring & desizing to remove natural impurities and the slashing compounds. Enzymes are usually used in India to hydrolyze the starch, acids may also be used for the is purpose. Caustic soda, soda ash, detergents etc. are also used in this section.

Bleaching operations use oxidizing chemicals like peroxides & hyper chloride to

remove natural coloring material. The section contributes about 10% of the total pollution load.

Mercerizing consists of passing the cloth through 20% caustic soda solution. This process includes the strength elasticity luster & dye affinity. Waste from this section is recycled after sodium hydroxide recovery. Negligible waste which may come out of this section contributes little BOD but a high degree of alkalinity.

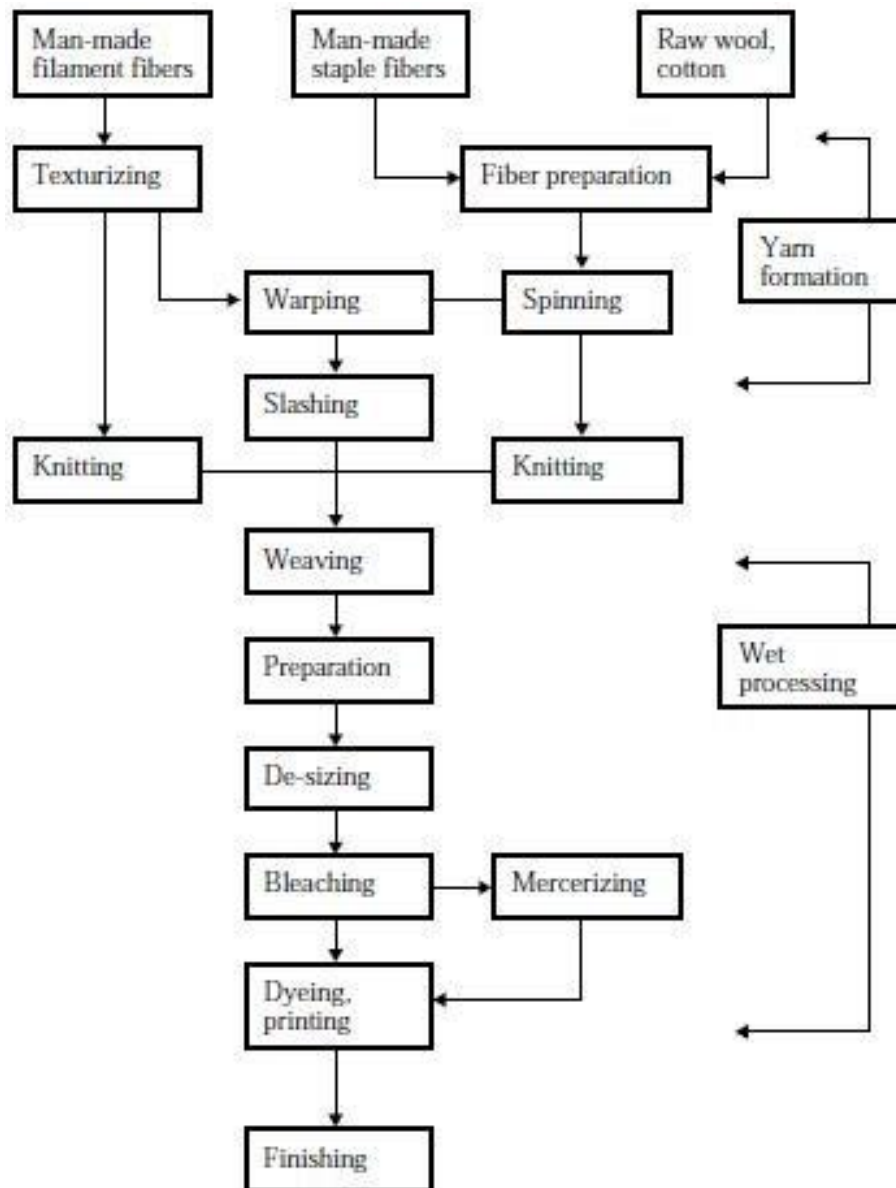

Dyeing may be done in various ways, using different types of dyes and chemical classes of dyes include Vat dyes, developing dyes etc. color from the dyes vary widely and although these are not usually toxic, they are treated separately. Thickened dyes are used for probing and subsequent fixation. After fixation of the prints, the fabric is given a thorough wash to remove the unfixed dyes. The finishing section of the mill imparts various types of chemicals are used for various objectives. These include starches, dextrans, natural & synthetic waxes, synthetics etc. Therefore a composite waste from an integrates cotton textile

mill may include the following organic & inorganic substances starch, carboxyl methyl cellulose, sodium hydroxide, detergents, peroxides, hyperchloride dyes & pigments, sodium gums, dextrans, waxes, sulphides, soap etc. Depending on the process & predominant dye used, the characteristics of the mill waste varies widely.

The characteristic of a typical Indian cotton textile mill is given below.

Characteristics	Value
pH	9.8-11.8
Total alkalinity	17.35 mg/lt
BOD	760 mg/lt
COD	1418 mg/lt
Total solids	6170 mg/lt
Total Chromium	12.5 mg/lt

### Effect of textile mill waste on receiving streams/sewers

If the mill waste water is discharged into streams, it causes depletion of DO of the stream. This is due to the settlement of the suspended substances and subsequent decomposition of the same in anaerobic condition. The alkalinity and toxic substances like sulphides & chromium affects the aquatic life and also interferes with the biological treatment processes. Some of the dyes are also found to be toxic. The color often renders the water unfit for use for side. The presence of sulphides makes the waste corrosive particularly to concrete structures. All treatment plants should be planned giving serious consideration for the reduction of waste volume & strength, through process of chemical substitution, chemical recovery & recycling of water. The pollution load from a textile, mill is dealt with operations like segregation, neutralization, equalization, chemical ppt, chemical oxidation & biological oxidation. Several chemicals are used to reduce the BOD by chemical coagulation such as alum, ferric sulphate, ferrous sulphate & ferric chloride, lime or  $H_2SO_4$  is used to adjust pH in this process. The dye waste may be economically treated by biological methods prior equalization, neutralization & chemical oxidation.

A Composite waste, when free from toxic substances may be treated as efficiently as domestic sewage, as most of the textile mill wastes contain sufficient nutrients like nitrogen & phosphorous. Trickling filters, activated sludge process & stabilization ponds have been effective in treating textile mill wastes. Extended aeration is found to be very effective in treating strong wastes even without equalization & pretreatment.

### 5.3 Tanning Industry

The tanning industry is one of the old industries in India. Usually the tannery wastes are characterized by strong color high BOD, high pH & high dissolved salts. The concentrated growth of this industry in certain localities has shown how the waste from this industry can issue severe damage to the water environment in the vicinity. In view of this peculiar pollution potential and the increasing demand for good quality water, it has become essential to treated it waste to a certain degree prior to its disposal.

#### Manufacturing process

Tanning process consists of 3 basic stages

1. Preparation of hides for tanning
2. Tanning proper
3. Finishing

### **Preparation of hides for tanning**

In the first stage, the hides are used to remove dirt and preservative salts use earlier, and soaked in fresh water containing sodium chloride and preservative chemicals 1-5 days. The soaked hides are then washed again in sufficient water.

The washes hides are then lined with a paste of lime in sodium sulphide. Lined hides are then mechanically cleaned off hairs & flushing in wooden Vats with running fresh water. The subsequent operations are de liming and bating. Bating prepares the hides for tanning by reducing pH. Reducing the swelling and removing the degradation products in it. The deliming and bating is carried out in vertically ground in warm solution of ammonium salts and commercial prepared enzymes. An additional treatment known as pickling is required for preparing the height for "chrome tanning". Which involve treatment of hides with sodium chloride and acids.

### **Tanning proper**

The second stage of leather making, the tanning, involves the treatment of hides to make them non putrescible and soft even when dried. Depending on the type of product, either vegetable substances containing natural tanning's such as extract of barks, wood, nuts etc. or inorganic chroming salts are used as tanning agents. The use of synthetic tanning materials is expensive and is not adopted anywhere in India.

Vegetable tanning is used for leather, while chrome tanning is used for light leathers. In Chrome tanning process the tanning is done in the same vat after one day of pickling by adding the solution of chromium sulphate. After 4 hours of tanning, the leather is bleached with the dilute solution of sodium sulphate and sodium carbonate in the same vat. The chrome tanned leather is then pulled out and half of the spent liquor is thrown out and remaining is reused and along with a fresh volume of water. The vegetable tanned leathers are washed after the tanning proper.

### **Finishing**

The third stage of finishing consists of stuffing and fat liquoring followed by dyeing. Dyeing can be done using synthetic stuffs.



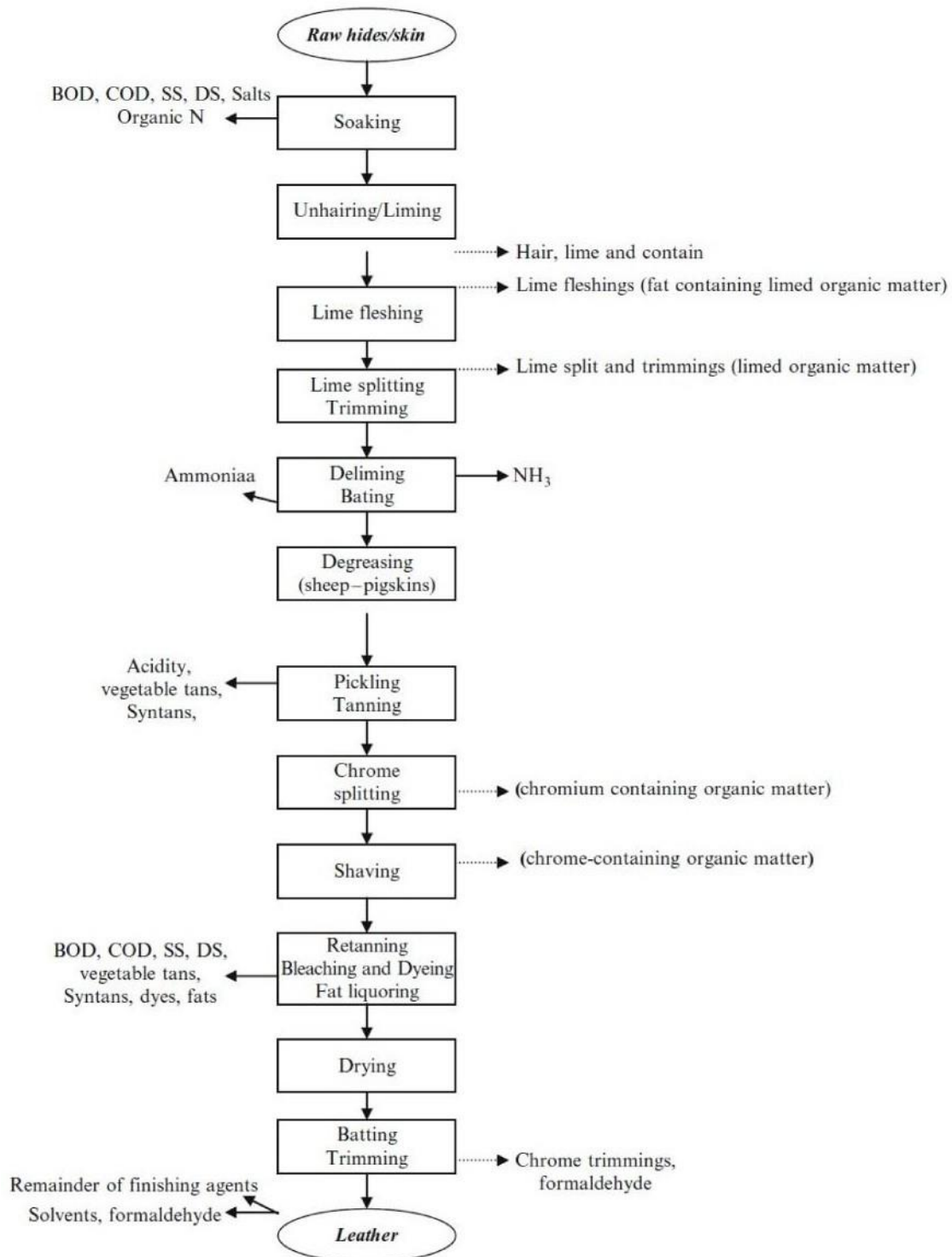

### Sources and characteristics of waste water

The waste water originates from the all operations in the tanning process. The waste may be classified as continues flow water, and intermittent flow waste. Continues flow waste consists of wash water after various processes and comprises of large portions of the total waste and are relatively and less polluted then the other one. Spent liquors belonging to soaking, liming and batting, pickling, tanning and finishing operation are discharged

intermittently. Although small in volume, they are highly polluted and contain varieties of solute and organic and inorganic substances.

The spent and soaked liquor contains soluble proteins of the hides, dirt and large amount of common salt where salted hides are process. This spent liquor under goes putrefaction very rapidly as it offers a good amount nutrient and favorable environment of bacterial growth. The growth of pathogenic – anthrax bacteria in this waste is also reported.

The spent lime liquor contains dissolved and suspended lime, colloidal proteins and their degradation products, sulphides emulsified fatty matters and also carrying a sludge composed of unreacted lime, Calcium sulphide and calcium carbonate. As such the spent lime liquor as a high alkalinity and moderate BOD and high ammonia nitrogen content.

The spent bate liquor contains high amount of organic and ammonium nitrogen due to the presence of soluble skin proteins and ammonia salts used in bating.

The vegetable ton exact containing tannins and also non tannins. Tannins are of high COD but relatively low BOD value. While non tannins including inorganic salts, organic acids and salts and sugar are of high BOD and COD. The spent vegetable tanning liquor is the strongest individual waste in the vegetable tannin having the highest BOD and very strong dirty brown color.

The spent pickling and chrome tanning waste comprises of as small volume, having a low BOD and contains traces of proteins impurities, sodium chloride and minerals acids and chromium salts. Chromium is known to be highly toxic to the living aquatic organisms.

Table shows the characteristic of Indian Tannery Industrial wastewater

Item	Spent soak liquor	Spent lime liquor	Spent delime liquor	Spent bating liquor	Spent vegetable tan liquor	Spent chrome tan liquor	Spent dyeing liquor
pH	8.4	12.8	9.3	9.9	5.4	3.2	6.2
Alkalinity as CaCO <sub>3</sub> , mg/L	600	1600	800	600	-	-	-
Acidity as CaCO <sub>3</sub> , mg/L	-	-	-	-	2560	5400	1000
Chloride, mg/L	16800	8900	400	240	3000	-	1000
Total solids, mg/L	35800	38240	27450	5000	34800	7480	4255
Suspended solids, mg/L	4500	3590	445	1060	2660	705	1255
COD, mg/L	3584	12000	2500	2374	30240	3584	6720
BOD, mg/L	708	7300	775	887	16000	-	-

### Effects of waste on streams and sewage plant

Tannery waste characterized by high BOD, high suspended solids and strong colors. The waste when discharged into streams they deplete the DO very rapidly due to both chemical and biological oxidation of sulphide and organic compounds. A secondary pollution of streams may occur due to the deposition of solids near the discharge points and its subsequent putrefaction. The gas evolved during this process as got a typical foul odor.

Chlorides in excess of tolerance limits (500mg/ L) render the water unsuitable for future use. The chromium is toxic to aquatic life and inhibits the growth of fish in the stream. Even the lagooning of the untreated tanning waste on open land may adversely affect the ground water and near the surface water sources due to seepage of dissolved solids. This makes the soil unsuitable for cultivation for this high salt content.

The tannery waste when discharged into sewer not only chokes the sewer due to the deposition of solids but also reduces the cross section of the sewer arising out of the lime encrustature.

Chromium compounds in excess of 10-20mg disrupt the operation of the trickling filter. Sulphides are also toxic to the micro organisms are removed along with the sludge. The sludge is dried over sand drying beds and can be used as good manure. Chemical coagulation (Alum, ferric chloride, and ferrous sulphate) with or without prior neutralization followed by biological treatment is necessary for better quality of effluent.

### **Treatment of wastewater**

The method of treatment of tannery waste may be classified as physical, chemical and biological. The physical treatment includes mainly screening and primary sedimentation. Screen are required to remove fleshing, hairs and other floating substance. A continuous flow sedimentation tank, designed on maximum hourly flow with 4 hrs of detention, and is found to be effective in 90% removal of suspended solid. About 98% of the chromium is precipitated in the primary sedimentation tank and is removed along with the sludge. The sludge is dried over sand drying beds and can be used as good manure. No appreciable reduction of dissolved solids, BOD, COD, color and chloride can be achieved in the physical treatment processes.

Chemical coagulation with or without neutralization, followed by biological treatment is necessary for better quality of the effluent. Several coagulants like alum, ferric chloride and ferrous sulphate have been tried for chemical coagulations. Chemical coagulation with ferric chloride alone is reported to be quite effective in the removal of tannin and COD.

Biological treatment of the tannery waste, in activated sludge process, after mixing with municipal wastewater in a suitable proportion, and using acclimatized microorganism is capable to reduce the BOD, COD and tannin by about 90%. Trickling filter may also be used for effective removal of BOD, COD and color. The low cost treatment methods may effectively be used for the treatment of tannery wastes. Both oxidation pond and anaerobic lagoons are recommended for small and isolated tanners. Anaerobic lagoons require less land area and nutrient addition compared to those in oxidation ponds.

### **5.4 Cane Sugar and Distillery Industry**

In countries like India, Cuba & Jamaica the sugar is produced from sugar canes, while in many other but roots are used as raw material for the sugar production. In India, most of the sugar mills are situated in the country side & operate for about 4-8 months just after the harvesting of the sugar canes. A large volume of waste of organic nature is produced during the period of production & normally they are discharged on to land or onto the nearby water source usually small streams practically without treatment.

## Manufacturing process

The sugar cane is normally harvested manually in India, which eliminates the carriage of soil & trashes to the factory along with the sugar canes. The sugarcanes are cut into pieces & crushed in a series of rollers to extract the juice in the mill. Then for sugar canes of Lime is then added to the juice & heated where in all the colloidal & suspended impurities are coagulated. Much of the color is also removed during lime treatment. The coagulated juice is then clarified to remove the sludge. The clarifier sludge is further filtered through filter process & then disposed off as solution waste. The filtrate is recycled to the process and the entire quantity of clarified juice is treated by passing sulfur dioxide gas through it. The process is known as sulphitation process. Here color of the juice is completely bleached out due to this process.

The clarified juice is then pre- heated & concentrated in evaporators & vacuum pans. The partially crystallized syrup from the vacuum pan is known as Masecuite is then transferred to the crystallizers, where complete crystallization of sugar occurs. The masecuite is then centrifuged, to separate the sugar crystals from the mother liquor. The spent liquor is discarded as black strap molasses. The sugar is then dried & bagged for transport.

The fibrous residue of the mill house known as bagasses may be burnt in the boilers or may be used as raw materials for the production of paper product. The black strap molasses may be used in the distilleries.

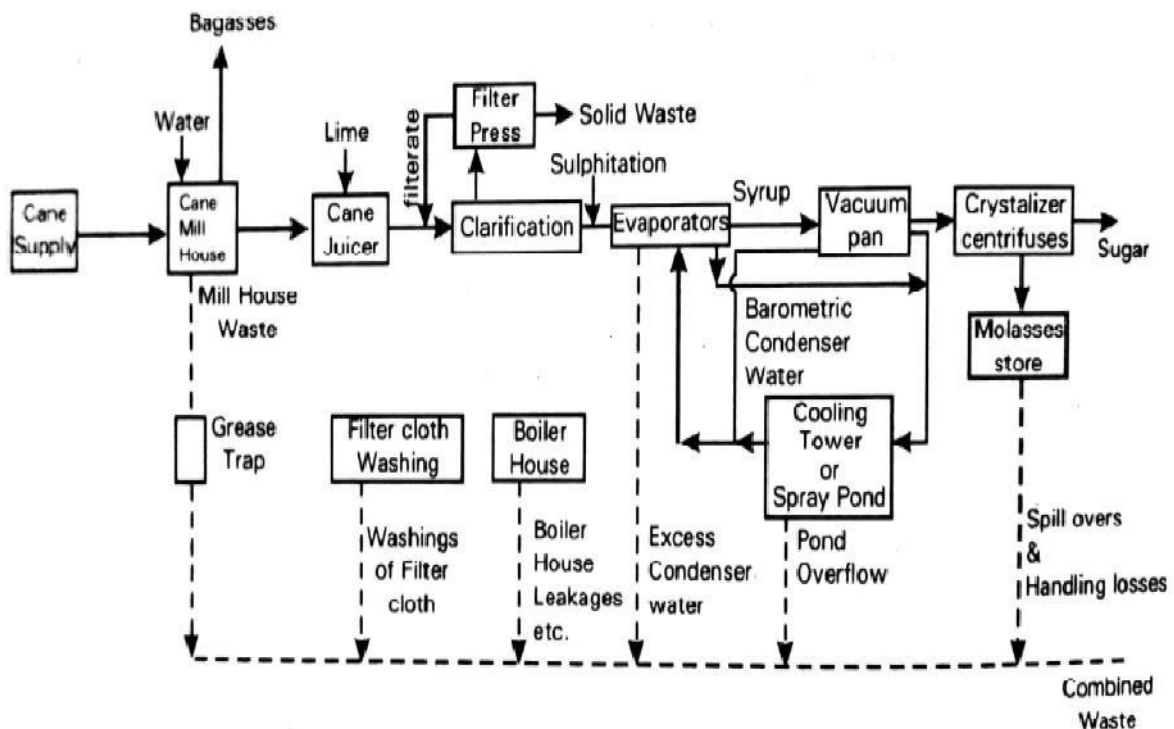

## Sources and characteristics of wastes

Waste from the mill house include the water used as splashes to extract maximum amount of juice & those used to cool the roller bearings. As such the mill house waste contains high BOD due to the presence of sugar & oil from the machineries. The filter cloths

used for filtering the juice needs occasional cleaning. The wash water thus produced through small in volume, contains high BOD & suspended solids.

A large volume of water is required in the Barometric condensers of the evaporators & vacuum pan. The water is usually partially or fully circulated after cooling through a spray pond. This cooling water gets polluted as it picks up some organic substances from the vapour of boiling syrup in evaporation & vacuum pans. This polluted water, instead of recirculated is discarded as excess condenser water. These discharges contribute substantially to the waste volume & modulated to BOD in many sugar mills.

Additional waste originates due to the leakages & spillages of juice, syrup & molasses in different sections. The periodical washings of the floor through small in volume have got very high BOD. The periodic blow off of the boilers produces another intermittence waste discharge. This waste is high in suspended solids, low in BOD & usually alkaline.

Characteristics	Value
pH	4.6-7.1
Total solids	870-3500 mg/l
BOD	300-200 mg/l
COD	600-4380 mg/l
Total suspended solids	220-800 mg/l
Total Nitrogen	10-40 mg/l

### Effects of wastes on receiving water

The fresh effluent from the sugar mill decomposes rapidly after few hours of stagnation. It has been found to cause considerable difficulties when this effluent gets an access to the water course particularly the small & non perennial streams in the rural areas. The rapid depletion of oxygen due to biological oxidation followed by anaerobic stabilization of the waste causes secondary pollution of offensive odor, black color & fish mortality.

### Treatment of the wastewater

Like any other industry the pollution load in sugar mills can also be reduced with a better water and material economy practiced in the plant. Judicious use of water in various plant practices & it recycle, wherever practicable, will reduced by recycling cleaning of floors or floor washings using controlled quantity of water will also reduce the volume of waste to certain extent.

The organic load of the waste can only be reduced by a proper control of the operations. Over loading of the evaporates & the vacuum pans and the extensive boiling of the syrup leads to a loss of sugar through condenser water & this in turn increases both volume & strength of the waste effluent. Disposal of the effluent on land as irrigation water is practiced in many sugar mills, but it is associated with odor problems.

Anaerobic treatment of the effluent using both digesters and lagoons has been found to be very effective & economical. A BOD reduction of both 70-88% was observed in pilot plant study with an anaerobic digester, where BOD loading was 0.65-1.79 kg/m<sup>3</sup>/day with a detention time of 2- 2.4 days at a controlled temperature of 37°C.

The effluents of the anaerobic treatment units are found to contain sufficient nutrients (nitrogen & phosphorous) as such further reduction of BOD can be accomplished in aerobic waste stabilization ponds.

### 5.5 Dairy Industry

With increase in demand for milk & milk products, many dairies of different sizes have come up in different places. These dairies collect the milk from the producers & then either packed it for marketing or produce different milk foods according to their capacity. Large quantity of waste water originates due to their different operations. The organic substances in the wastes comes either in the form in which they were present in milk or in a degraded form due to their processing. As such the dairy wastes though biodegradable are very strong in nature.

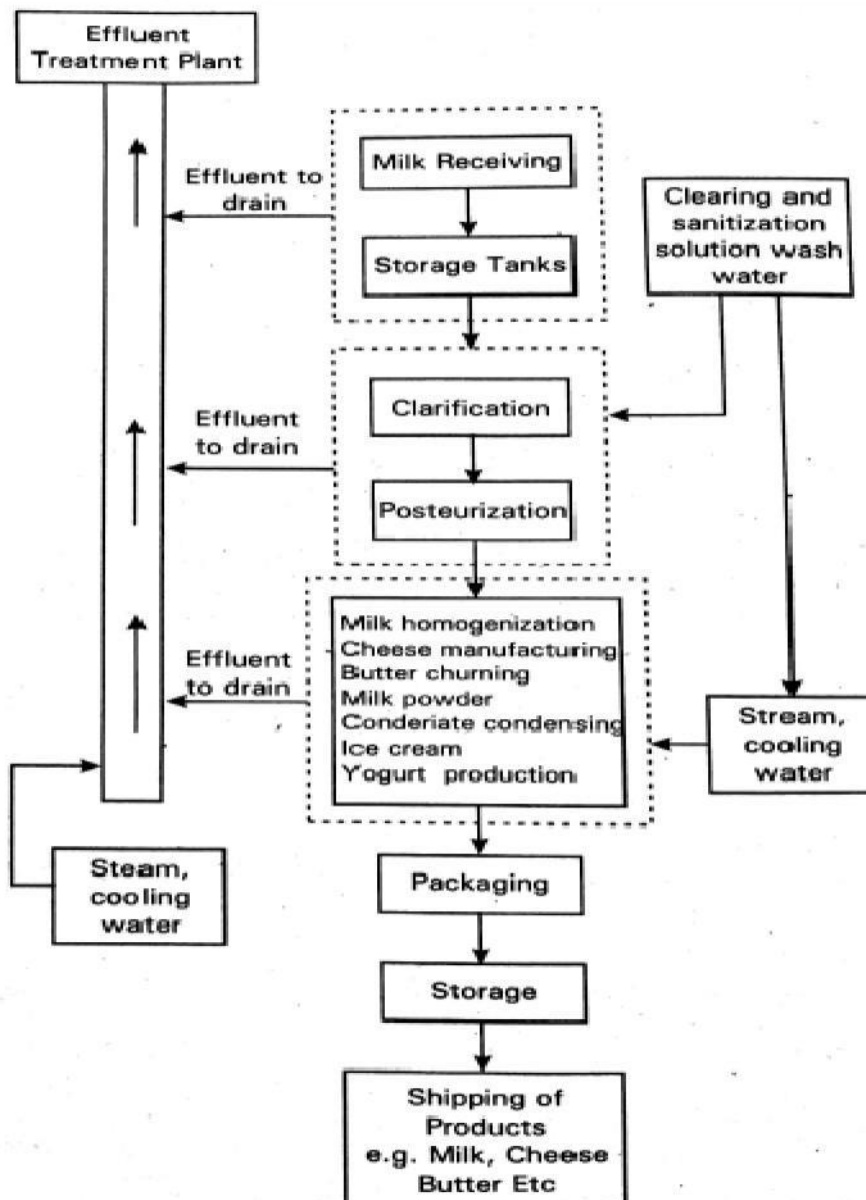

#### Processing and sources of wastes

The liquid waste from a large dairy originates from the following sections or plants. Receiving station bottling plant, cheese plant, butter plant, casein plant, condensing plant, dried milk plant & ice cream plants. Wastes also come from water softening plant & from

bottle and washing plants. At the receiving station, the milk is received from the farmers and is emptied into large containers for transport to bottling of other processing plants. The empty can be rinsed, washed and sterilized before returning to the farmers. At the bottling plants the raw milk delivered by receiving station is stored. The processing includes cooling, filtration, clarification, pasteurization and bottling.

In the above two sections, the liquid wastes originate out of rinse & washings of bottles, cans & equipments & thus contain milk drippings and chemicals used for cleaning containers & equipments.

In a cheese plant, the milk (whole milk or skimmed milk) is pasteurized and cooled and placed in a vat, where a starter (lactic acid producing bacterial culture) and rennet are added. This separates the casein of the milk in the form of curd. The whey is then withdrawn and the curd compressed to allow excess to drain out. Other ingredients are now added and the cheese blocks are cut and packaged for sale. Waste water from this plant includes mainly the discarded whey and wash water used for cleaning vats, equipments floor.

In the creamery process the whole milk is pre heated to about 30<sup>0</sup>C to separate the cream from the milk. In a butter plant, the cream is pasteurized and may be ripened with a selected acid and a bacterial culture. This is then churned at a temperature of about 7- 10<sup>0</sup>C to produce butter granules. At the proper time the butter ilk is drained out of the churned & the butter is washed & after standardization packaged for sale. Butter milk and wash waters used to clean the churns and small quantity of butter comes out as waste from the butter plants.

The skimmed milk may now be sent for bottling for human consumption or for further processing in the dairy for other products like non fat milk powders. Milk powders are produced by evaporation followed by drying by either roller process or spray process. The dried milk plant wastes consist of chiefly of wash waters used to clean containers & equipments.

The scoured or spoiled milk and some time the skimmed milk are processed to produce caseins used for preparation of some plastics. The process involves the coagulation & precipitation of the casein by the addition of some mineral acids. The wastes from this section include whey, washings and the chemicals used for precipitation. Very large dairies also produce condensed milk & ice creams.

In addition to the wastes from all the above milk processing units, some amount of uncontaminated cooling water comes as waste. These are usually recirculated. The dairy wastes are very often discharged intermittently. The nature & composition of the waste also depends on the types of products produce & the size of the plants.

### **Effects of the waste on the receiving water and sewage plants**

As the dairies are usually situated in rural areas or in small towns, the question of discharging the dairy waste in to the sewers does not arise.

The waste is basically organic in nature. This is also slightly alkaline when fresh. When these wastes are allowed to go into the stream without any treatment, a rapid depletion of DO of the stream occurs along with growth of sewage fungi covering the entire bottom of the stream. The waste is said to carry occasionally, the bacteria responsible for tuberculosis (TB). Though alkaline in fresh condition the milk waste becomes acidic due to the decomposition of lactose into lactic acid under anaerobic condition.

The resulting condition precipitates casein from the waste, which decomposes further into a highly odorous black sludge. At certain dilution the dairy waste is found to be toxic to fishes also.

### **Treatment of the dairy waste**

Due to low COD, BOD ratio the dairy wastes can be treated efficiently by biological processes. Moreover, these wastes contain sufficient nutrients for bacterial growth. But for economical reasons, attempt should be made to reduce the volume & strength of the waste. This can be accomplished by

1. Prevention of spills, leakages & dropping of milk from the cans.
2. By reducing the amount of water for washes.
3. By segregating the uncontaminated cooling water and recycling the same.
4. By utilizing the buttermilk and whey for the production of dairy bi products of good market value.

Due to the intermittent nature of the waste, it is desirable to provide equalization tank, with or without aeration, before the same is sent for biological treatment. A provision of grease trap is also necessary as a pretreatment to remove fat & other greasy substances from the wastes. Aeration for a day not only prevents the formation of lactic acid, but also reduces the BOD by about 50%.

Both high rates trickling filters & activated sludge plants can be employed very effectively for a complete treatment of the dairy waste. But these conventional methods involve much maintenance, skilled methods like oxidation ditch, aerated lagoon, waste stabilization pond etc., can be employed with simpler type of equipments & less maintenance.

Use of the dairy waste for irrigation after primary treatment in an aerated lagoon may be a good answer for the disposal of dairy wastes.

### **5.5.1 Distillery Industry**

Production of ethyl alcohol in distilleries based on cane sugar molasses constitutes a major industry in Asia and South Africa. The world's total production of alcohol from cane molasses is more than 13 million<sup>3</sup>/annum. The aqueous distillery effluent stream known as spent wash is a dark brown highly organic effluent and is approximately 12-15 times by volume of the product alcohol. It is one of the most complex, troublesome and strongest organic industrial effluents having extremely high COD and BOD values.

#### **Manufacturing process**

In India bulk of the alcohol is being produced from sugar cane molasses. Molasses is a thick viscous byproduct of the sugar industry which is acidic in nature, rich in salts, dark brown in color and it also contains sugar which could not be crystallized. For manufacturing alcohol, the molasses is diluted with water into a solution containing 15-16% of sugars. This solution is then inoculated with yeast strain and is allowed to ferment at room temperature. The fermented liquor containing alcohol is then sent to an overhead tank without separation of the solid materials. The same is then degasified and the alcohol is stripped leaving a spent wash. The crude alcohol is then redistilled and stored in bags. Some of the alcohols like gin attain their final form at this stage; some other like whisky requires ageing in charred oak



wood barrels. For manufacture of alcoholic beverages, the alcohol is, if required, matured and blended with malt alcohol and diluted to requisite strength to obtain the desired type of liquor/Indian Made Foreign Liquor (IMFL). This is bottled in bottles of various sizes for the convenience of consumers.

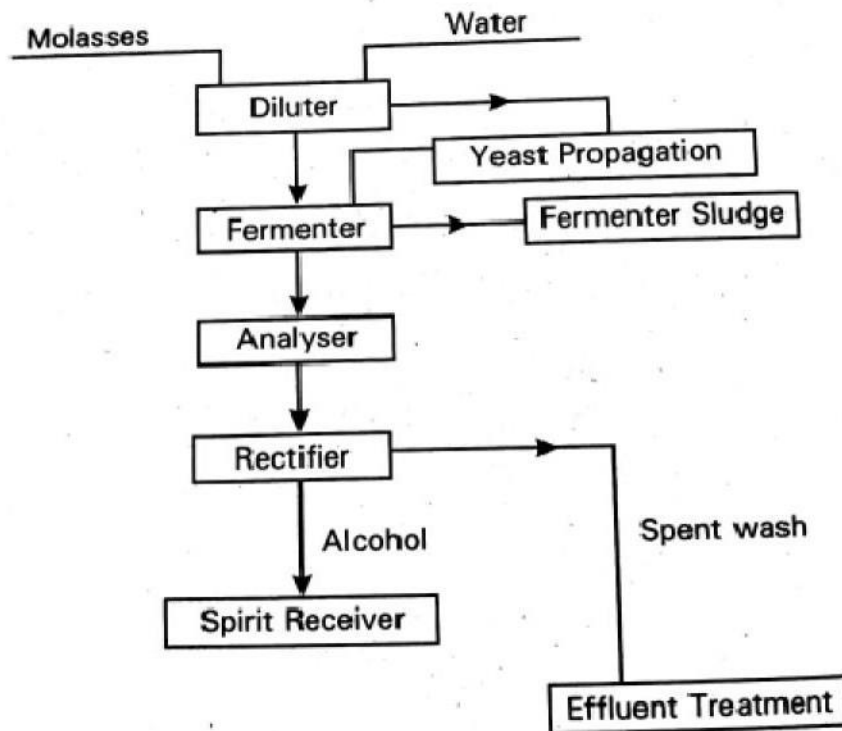

### Origin and characteristics of distillery wastes

The spent wash is the major polluting component of the distilleries and it is reported to be 10-15 times the final product in volume. The other pollutants include yeast sludge, which deposits at the bottom of fermentation vats. In most of the distilleries in India this yeast sludge is mixed with the spent wash and discharged. In addition to these, major BOD and solids contributing wastes, floor washes waste cooling water and wastes from the operations of yeast recovery or by products recovery processes also contribute the volume of these waste.

### Effects on receiving streams/ sewers

All the above types of wastes discussed earlier are not toxic to the aquatic life of the receiving stream. But due to their high BOD content, they depict the DO of the receiving water. This results in anaerobic decomposition of this organic solids, both settled & suspended, producing a malodorous condition over the fairly long stretch of the stream. The conditions further deteriorate due to the growth of sewage fungi. The dark color of the stream renders it unaesthetic.

Brewery waste, which is comparatively of lesser strength, may be discharged in a fresh condition into the sewers to the extent of 3-5 % of the domestic sewage. The strong acidic or putrefied brewery waste will disrupt the normal biological activities of the waste treatment

plants. For the sake of safe the brewery waste, if discharged into the sewers must be screened & pre treated by lime. The very high BOD content of the distilled waste makes it non amenable to the aerobic biological treatment and as such it cannot be discharged into municipal sewerage system directly.

Brewery wastes being comparatively less strong can be treated by aerobic biological treatment, after screening and neutralization. Usually, the biological treatment is accomplished by two stage process for 90-94% BOD reduction. A flow sheet of one such brewery waste treatment plant employing high rate trickling filters is shown in fig. When sufficient land is available, the brewery waste may be used for broad irrigation after neutralization to utilize the fertilizing components of the waste.

## **5.6 Steel Industry**

Integrated steel plants usually consist of five main units such as coal washery, coke oven, blast furnace, steel melting shop and rolling mills

### **Coal washery and its wastewater**

The coal needs some processing to make it suitable for use in coke ovens. The main objective of such treatment is the removal of solid foreign matter present in the coal. Generally the processes in a coal washery include crushing, screening and wet washing of coal. In the wet process the coal is separated from the impurities using the principle of differential settling. Water used for washing is recycled and re-used after sedimentation. But in spite of all care taken to ensure maximum reuse, appreciable quantity of wash water containing coal fines and other impurities like shale, clay and small amounts of other minerals like calcite, gypsum, kaolin, pyrite etc, comes out as waste.

### **Coke ovens and their wastewater**

The production of coke involves the carbonization of bituminous coal by heating in the absence of air at a temperature range of 900-1100<sup>o</sup>C in an oven, which drives off all volatile portions in the coal. The gas which is evolved containing the volatile matters is collected through the stand pipes and is cooled in stages. In the first stage the gas is cooled to about 80<sup>o</sup>C by spraying cold liquor over the gas, thereby producing mainly tar as the condensate. In the second stage by a further cooling to about 30<sup>o</sup>C, condensate containing additional tar and ammonia liquor is produced. These two condensate liquors after the separation of tar in a tar-decantor, are recycled as sprays in the first stage. The excess liquor known as ammonia liquor, containing mainly ammonia and various other compounds is subjected to distillation for the recovery of ammonia, the waste is sent for further treatment. After the second stage of cooling, i.e., in the third stage, the gas is compressed and cooled for further recovery of chemicals

The coal after being carbonized is removed from the oven and quenched by cold water. About 30% of the quenching water is evaporated while the remaining water containing coke fines comes out as waste. This wastewater is usually recirculated through settling ponds and does not present any pollution problem.

**Blast furnace and its wastewater**

Blast furnace is a basic unit in an integrated steel plant. Essentially the blast furnace process consists of charging iron ore & coke as fuel, limestone & dolomite as fluxing material into the top of the furnace & blowing heated air into the bottom. Pig iron is the metallic product of this unit. Appreciable quantity of water is used in blast furnace for the purpose of cooling & gas cleaning operations. However, the cooling water normally remains uncontaminated & is reused after cooling. The entire quantum of wastewater originates from the gas cleaning operations.

**Steel melting and its waste**

In the steel melting, the pig iron obtained from the blast furnace is further treated to produce ingots. The basic principle involved is the oxidation of unwanted impurities in the pig iron which lead to the production of steel ingots. Water requirement in the steel melting processes lies in keeping the furnace body cool. And as such this water remains uncontaminated & is reused

**Rolling mills & their waste**

The steel ingots obtained from the steel melting are rolled to different products in the rolling mills. However, the ingots are heated first in the soaking pits until these are plastic enough for economic reduction by rolling. Ingots are usually rolled into blooms, billets or slabs depending upon the final product. These rolled blooms, billets and slabs are then cooled & stored & subsequently sent to another mill, where these are re-rolled to produce finer products.

During the process of rolling of ingots, blooms, billets and slabs, lots of scales are given off and are collected in the scale flume, below the roll tables. These scales are flushed down with high pressure water and are collected at the scale pit. The rolls also get heated up during the process, and cool with liberal supply of water. This water also joins the waste water flow through flume. Naturally it carries a lot of oil and grease.

**Effects of the steel plants waste on receiving water**

Pollutants that of main concern in integrated steel plant waste are suspended solids, cyanides, acids, ammonium compounds, phosphates, phenols, oils etc. If the spent ammonical liquor is discharged into a stream without any treatment, the phenol alone can disturb the ecology of the receiving stream. It carries several elements which are toxic to aquatic life; among them some are objectionable to human consumption.

When phenol bearing water is chlorinated, chlorophenols will be formed. These chlorophenols are detected by taste in drinking water even at a concentration of 0.005mg/L. The black suspended solids of an untreated waste discharge pollute the bed & the banks of the stream with a thick deposit. The reason for eutrophication in stream is generally attributed to the presence of excess amount of phosphates in the effluent.

**Treatment of wastewater Conventional Method**

- Primary treatment consists of temporarily holding the sewage in a quiescent basin where heavy solids can settle to the bottom while oil, grease and lighter solids float to

the surface. The settled and floating materials are removed and the remaining liquid may be discharged.

- Secondary treatment removes dissolved and suspended biological matter. Secondary treatment is typically performed by indigenous, water-borne micro-organisms in a managed habitat. Secondary treatment may require a separation process to remove the micro-organisms from the treated water prior to discharge or tertiary treatment.
- Tertiary treatment is sometimes defined as anything more than primary and secondary treatment. Treated water is sometimes disinfected chemically or physically (for example, by lagoons and microfiltration) prior to discharge into a stream, river, bay, lagoon or wetland, or it can be used for the irrigation of a golf course, green way or park. If it is sufficiently clean, it can also be used for groundwater recharge or agricultural purposes.

### 5.6.1 Cement Industry

Cement industry contributes much to air pollution & liquid effluents are not problem Raw materials

It is a compound made up of calcium oxide & silicon di oxide along with aluminium oxide, ferric oxide & magnesium oxide. Raw materials required for the manufacture of cement are lime, sand clay, shale, iron –ore & blast furnace slag.

#### Cement Manufacturing Process Phases

Production of cement completes after passing of raw materials from the following six phases. These are;

1. Raw material extraction/Quarry
2. Grinding, Proportioning and Blending
3. Pre-heater Phase
4. Kiln Phase
5. Cooling and Final Grinding
6. Packing & Shipping

#### Cement Manufacturing Process Phase 1: Raw Material Extraction

Cement uses raw materials that cover calcium, silicon, iron and aluminum. Such raw materials are limestone, clay and sand. Limestone is for calcium. It is combined with much smaller proportions of sand and clay. Sand & clay fulfill the need of silicon, iron and aluminum generally cement plants are fixed where the quarry of limestone is nearby. This saves the extra fuel cost and makes cement somehow economical. Raw materials are extracted from the quarry and by means of conveyor belt material is transported to the cement plant.

There are also various other raw materials used for cement manufacturing. For example shale, fly ash, mill scale and bauxite. These raw materials are directly brought from other sources because of small requirements.

Before transportation of raw materials to the cement plant, large size rocks are crushed into

smaller size rocks with the help of crusher at quarry. Crusher reduces the size of large rocks to the size of gravels.

### **Cement Manufacturing Process Phase II: Proportioning, Blending & Grinding**

The raw materials from quarry are now routed in plant laboratory where, they are analyzed and proper proportioning of limestone and clay are making possible before the beginning of grinding. Generally, limestone is 80% and remaining 20% is the clay.

Now cement plant grind the raw mix with the help of heavy wheel type rollers and rotating table. Rotating table rotates continuously under the roller and brought the raw mix in contact with the roller. Roller crushes the material to a fine powder and finishes the job. Raw mix is stored in a pre-homogenization pile after grinding raw mix to fine powder.

### **Cement Manufacturing Process Phase III: Pre-heating Raw Material**

After final grinding, the material is ready to face the pre-heating chamber. Pre-heater chamber consists of series of vertical cyclone from where the raw material passes before facing the kiln. Pre-heating chamber utilizes the emitting hot gases from kiln. Pre-heating of the material saves the energy and make plant environmental friendly.

### **Cement Manufacturing Process Phase IV: Kiln Phase**

Kiln is a huge rotating furnace also called as the heart of cement making process. Here, raw material is heated up to 1450 °C. This temperature begins a chemical reaction so called decarbonation. In this reaction material (like limestone) releases the carbon dioxide. High temperature of kiln makes slurry of the material.

The series of chemical reactions between calcium and silicon dioxide compounds form the primary constituents of cement i.e., calcium silicate. Kiln is heating up from the exit side by the use of natural gas and coal. When material reaches the lower part of the kiln, it forms the shape of clinker.

### **Cement Manufacturing Process Phase V: Cooling and Final Grinding**

After passing out from the kiln, clinkers are cooled by mean of forced air. Clinker released the absorb heat and cool down to lower temperature. Released heat by clinker is reused by recirculating it back to the kiln. This too saves energy.

Final process of 5th phase is the final grinding. There is a horizontal filled with steel balls. Clinker reach in this rotating drum after cooling. Here, steel balls tumble and crush the clinker into a very fine powder. This fine powder is considered as cement. During grinding gypsum is also added to the mix in small percentage that controls the setting of cement.

### **Cement Manufacturing Process Phase VI: Packing and Shipping**

Material is directly conveyed to the silos (silos are the large storage tanks of cement) from the grinding mills. Further, it is packed to about 20-40 kg bags. Only a small percent of cement is packed in the bags only for those customers whom need is very small. The remaining cement is shipped in bulk quantities by mean of trucks, rails or ships.

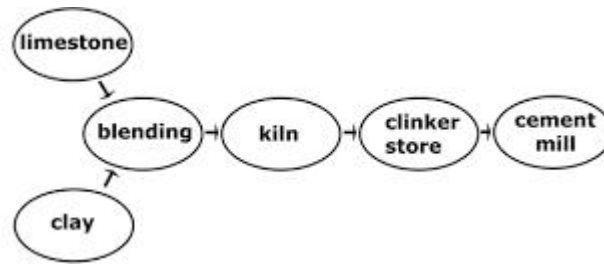

### Sources of effluent

Cooling water- It can be recycled after cooling as it does not contain harmful materials

Wet scrubbing effluent – Wet scrubbing of kiln dust yields an effluent that has a high pH value, alkalinity, suspended & dissolved solids like sulfate & potassium predominates.

### Wastewater and Industrial Process Wastewater Treatment

In cement industries water is used only for cooling operation of manufacturing process. Process wastewater with high pH and suspended solids may be generated in some operations. Generally water used for cooling purpose is recycled and reused in the process. Screening and for suspended solid reduction is done by using settling basin and clarifier. Water treated from waste water treatment plant should use for green belt development. This green belt also helps in minimizing noise pollution.

At lime mining site and cement plant contaminated streams of rain water should be directed to the waste water treatment plant and should use for industrial process. Storm-water flowing through pet-coke, coal, and waste material stockpiles exposed to the open air may become contaminated. Rain water should be protected from contacting from coal depot clinker and lime and fly ash storage area to prevent contamination by covering the storage area and should collect at some tank for further use in dust suppression system at plant. If storm-water does contact storage yard than it may indicate presence of high value of sulphate in soil and toxic metals like Zinc, Lead and Chromium in the dust and high TDS value in ground water.

### 5.7 Paper and Pulp Industry

The paper mills use the Pulp” as the raw materials which is again produced utilizing different cellulosic materials like wood, bamboo etc., in the pulp mills . The pulp & paper mill wastes characteristically contain very high COD & color. The presence of lignin in the waste, which is not easily biodegradable, makes the COD/BOD ratio of the waste very high. It may be noted that, the pollution potential of the paper mills are negligible compare to that of the pulp mills. As such, it is the pulp making process which is responsible for the pollution problem associated with the integrated pulp & paper mills.

### Manufacturing process & the sources of the waste

The volume & characteristics of the waste depends on the type & manufacturing process adopted & the extent of reuse of water employee in the plant. The process of manufacturing of paper & pulp making & then making the final product of paper.

In the pulp making phase, the chipped cellulose raw materials are digested with different chemicals in one tank under high temperature & pressure. The process thus loosens the cellulose fibers & dissolves the lignin & resin & other non cellulosic materials in the raw material. The kraft process or sulphate process of pulp making uses sodium, sulphate, sodium

hydroxide & sodium sulphide as the above mentioned digestive chemicals. Another process of pulp making known as sulphide process uses magnesium or calcium bisulphate & sulphurous acid as the digestive chemicals. The alkali process uses sodium hydroxide or lime for pulp making.

The spent liquor produced by the above process of digestion is known as “Black Liquor”. This is not only very rich in lignin content, but also contains a large amount of utilized chemicals. Therefore this black liquor is treated separately for the recovery. So while the entire quantity of the liquor is up hide process makes the colored waste from the section, in the kraft process, the same is produced due to the leakages, spillages or overflow only from the digester. The cellulosic fiber after being separated from the black liquor is washed & then partially dewatered.

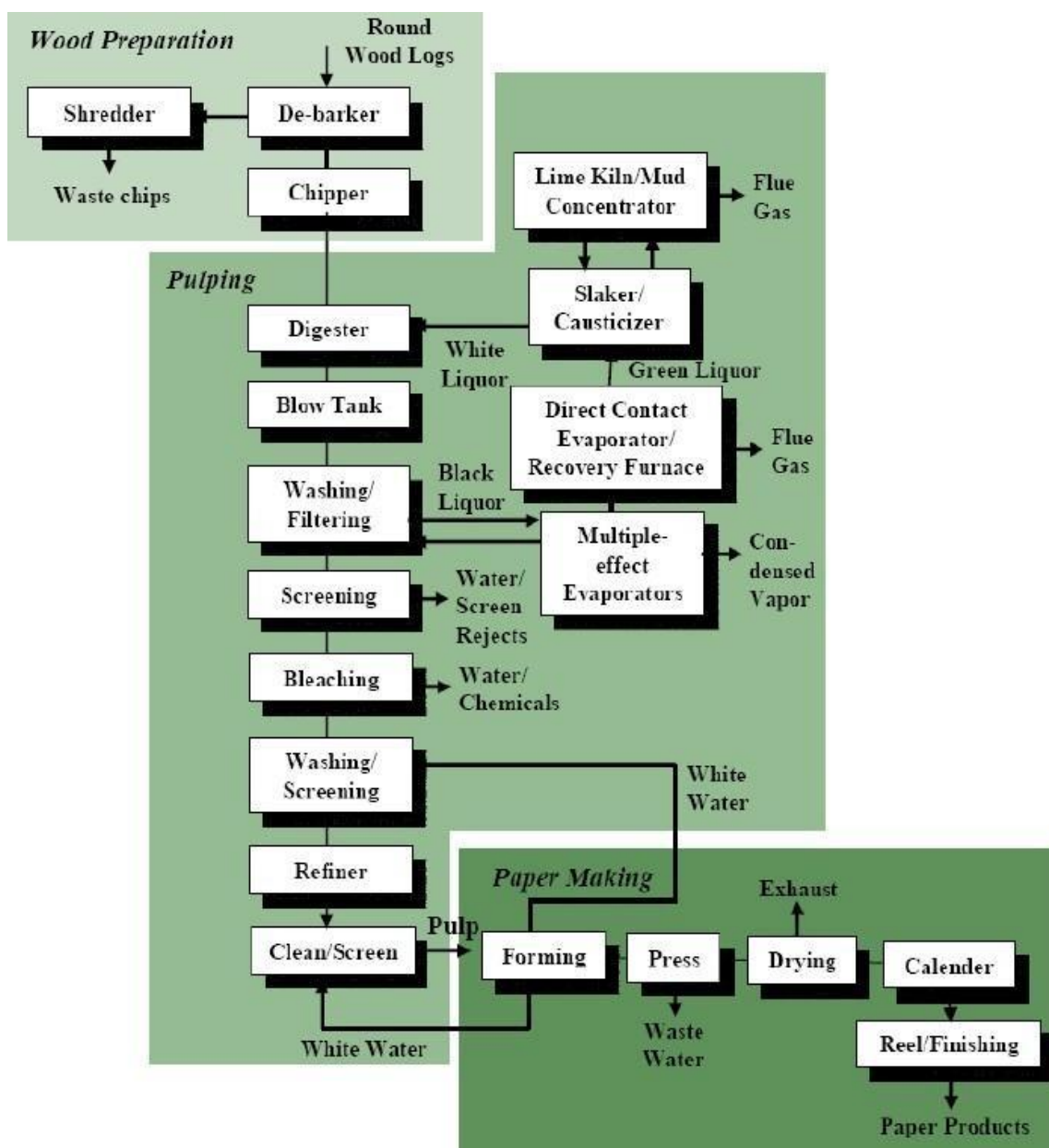

A concentrated wash water may be sent for chemical recovery) in the kraft process. The dilute wash water from the waste water. This volume of waste water is known as “Brown

stock wash” or “Unbleached Decter waste”.

The washed cellulosic fibers are then sent for the bleaching in 3 stages, where chlorine, caustic & hypochloride are used in successive stages. Waste waters from the first & the last stages are light yellow in color while that from the caustic extraction stage is highly colored. The bleached pulp is then sent for the paper mill. In the paper mill, the pulp is disintegrated & mixed with various filter materials like alum talc, etc and dyes on an along shaped especially pulp is refined in a machine known as “jorda”. The refined pulp is then diluted to proper consistency for paper making and passed through a screen to remove lumps or knots. Now this pulp is carried by a travelling belt of fine screen to a series of rolls, where the final product, the “paper” is produced. The drained water often called as “White water” forms the waste water from the paper mill section. This waste water contains fine fibers, alum, talc, etc. Usually the fibers are recovered from this waste; the treated liquid is reused for the wet chipping process.

The black liquor of the kraft process concentrated by evaporation and then incineration with the addition of sodium sulphate . The organic like lignin, resin etc are burnt off & the smell is dissolved in water .the resulting liquid is known as “green liquor” lime is now added to this liquor resulting in the formation of “ white liquor” & “ lime mud” containing chiefly digesting chemicals & is sent for using digester . The lime mud is calcined (by burning) to form calcium oxide, which is reused to recaustised other green liquors in to the white liquors. Beside those mentioned about, the small volume of waste water is also produced when the bark is removed from the raw wood & the latter is reduced to chips by wet process. Some very toxic waste materials are also generated during the process of chemical recovery from black liquor. Toxic materials like Dimethyl sulphide, methyl mercaptanetc also comes out with digester gases & forms colorless waste water after condensation.

### **Characteristics of pulp and paper mill wastes**

The chemical composition of the wastes depends on the size of the plant, manufacturing process and to a great extent on the material economy practiced (by way of recovery of chemicals and fibers) in the plant. In most of the small paper mills in India, the chemical recovery is not practiced due to economical reasons. As such, the pollution potential of the waste of smaller mills is higher than that of the larger mills. Generally, the pulp and paper mills wastes are characterized by very strong color, high BOD, high suspended solids, and a high COD/BOD ratio.

It may be noticed that too much difference is percent suspended solids contribution from different sections b/w the large and small mills arises due to following reasons.

Large mills produces large amount of lime mud and without being calcined, it is discharged as a waste. This lime mud in the large mills contributes 86.5% of the total suspended solids in the effluent. As such, the percent suspended solids from the digester section; bleaching paper mill section etc. assumes a very low value. On the other hand, no question of lime mud rises in small mill, as it does not have the chemical recovery plant. The waste volume percentage from the digester section is also higher in the case of small mill as the entire quantity of black liquor is wasted in such mills.



**Effects of wastes on receiving water courses or sewers**

Crudes pulp and paper mill wastes or insufficiently treated wastes cause very serious pollution problems, when discharged into the streams. The pollution extends over a very long stretch, due to the presence of slowly decomposing components in the waste. The fine fibers often close the water intake screens in the downstream side.

A toxic effect may also be induced upon the flora and funa of the stream due to sulphites and phenols in the waste.

The bottom deposits of ligniono cellulosic material near the point of discharge of the waste in a stream undergoes slow deposition and may lead to the DO depletion followed by the creation of anaerobic condition and destruction of aquatic life.

The question of discharge of this waste into municipal sewer does not arise due to the large amount and strange nature of the waste.

**Treatment of pulp and paper mill wastes Recovery**

The recovery of the process chemicals and fibers reduces the pollution load to a great extent, where the economy permits; the color bearing "black liquor" is treated for the chemical recovery. The process of recovery is described earlier. However in this process the lignin is destroyed. The same may also be recovered from the black liquor, by precipitation by acidulation with either CO<sub>2</sub> or sulphuric acid. These recovered lignins have got various uses in other industries. The alkaline lignins of kraft process may be used as a dispersing agent in various suspensions. Lignins may be used as raw materials for various othe substances like dimethyl sulphoxide, which is used as spinning solvent for polyacrylonitarite fibers. Activated carbons may also be manufactured from the lignings, recovered from the black liquors. The fibers in the white water, from the paper mills are recovered either by sedimentation or by flotation using forced air in the tank.

**Chemical treatment for the color removal**

The chemical coagulation for the removal of color is found to be uneconomical. Attempts have been made to remove color from the waste suing the lime sludge. The results are not encouraging. Massive lime treatment process developed in USA is said to be capable of removing 90% of color & 40- 60% of BOD from the waste. In this process, entire quantity of lime normally required for the recaustisation of green liquor into white liquor, is taken & allowed to react first with the colored waste effluent. The color is absorbed by the lime and sludge after setting is used in recausting the green liquor. The treatment of the green liquor with colored lime sludge results in the formation of dark brown liquor containing both desired cooking (digesting) chemicals and color producing component like lignin. This lignin bearing liquor is used as digester liquor and then destroyed along with the fresh lignins, in the subsequent operation of concentration and incineration in the process of chemical recovery.

**Activated carbon for color removal**

- a. Physical treatment for clarification: Mechanically cleaned circular clarifiers along are found to be capable of 70- 80% of the suspended solids from the combined mill effluent. About 95% - 99% removal of settle able solids can be accomplished in the clarifiers. However the BOD reduction is comparatively small and of the order of 25-

- 40% only.
- b. Biological treatment of the waste: Considerable reduction of BOD from the waste can be accomplished in both conventional and low cost biological treatment processes. Some are also effective in the reduction of color from the waste. If sufficient area is available, the waste stabilization ponds offer the cheapest means for treatment. Depth of these ponds vary from 0.9m- 1.5m, the detention period may vary from 12- 30 days. A minimum of 85% removal of BOD is found to be achievable.
  - c. Lagooning: In small mills where the black liquor is not treated separately for the chemical recovery, the strong black liquor must be segregated from the other wastes and stored in a lagoon. The content of the lagoon may be discharged into the stream under favorable conditions in the monsoon.

### 5.8 Pharmaceutical industry

Pharmaceutical industry produces varied type of products. They range from vitamins, synthetic drugs to antibiotics. The raw materials used are includes both organic and inorganic compounds. Some of the pharmaceutical plants do not generate any liquid effluents, while some others discharge little quantities of strong waste & others let out larger volumes.

Due to these wide variations a generalization cannot be drawn on the effluents of pharmaceutical industry. Most of the antibiotics such as penicillin. Streptomycin, lysine, sulfaquinazoline, nicarbazine & vitamins such as B1, B2, B12 and many steroids are prepared in the fermentation. The most waste produced in the fermentation process is the spent beer liquor. The spent beer liquor is the fermented broth remaining after the recovery of antibiotics and other valuables. It contains large amounts of organic materials, proteins and other nutrients and consequently the BOD of these effluents is abnormally high

Five main pharmaceutical wastes and their characteristics are as follows

1. Strong fermentation beers (small in volume but having 4000 to 8000 mg/LBOD)
2. Inorganic solids (waste slurry with little BOD)
3. Washings of floor and equipment ( large percentage of total volume and BOD from 600 to 2500ppm)
4. Chemical waste – solution or solvents which exert a substantial BOD when diluted with other wastes
5. Barometric condenser wastewater – resulting from solids and volatile gases being mixed with condenser wastewater causing 60 to 120 ppm BOD

The antibiotic wastes impart objectionable odors to stream and inhibit biological population and action. If they are discharged into sewer, they must be properly diluted; otherwise they affect the sewage treatment.

The volume and composition vary from unit to unit. Approximately 1000 to 3000 liters of waste will be discharged per 100 kg of products manufactured. No specific conclusion on the characteristics of the effluents can be drawn. In general, they are either highly acidic or highly alkaline and possess a high BOD and COD. Some of the effluents contain toxic substances like cyanides.

If the wastes are discharged into stream, they deplete the dissolved oxygen immediately.

These are corrosive due to their high acidity/alkalinity. Further, some of the substances present in them are toxic to aquatic life.

### **Effects of the waste on receiving water sewer**

If a crude waste from an antibiotic waste is discharged into a stream, it not only imparts an objectionable odour to the stream but also adversely affects the biological process in it. This waste should not be allowed to discharge into a municipal sewer unless the sewage treatment plant is properly designed to handle a widely varying and concentrated waste from such a plant.

### **Treatment of wastewater Antibiotic wastes**

Equalization, neutralization and clarification are the essential steps involved in the primary treatment of these waste. Anaerobic digestion and controlled aeration are proved to be the effective secondary treatments. Activated sludge and oxidation ditch are also employed in some pharmaceutical manufacturing units. The effluent from secondary treatments may be passed on to sand filters to produce effluent of better quality

Sometimes, the antibiotics wastes are evaporated and incinerated. Residues from penicillin and other antibiotics are dried and used in stock food. It is reported that a vacuum dried mycelium from the manufacture of penicillin can be digested to produce methane while reducing the organic matter content by about 55%.

### **Synthetic drug wastes**

The type of treatment largely depends on the products manufactured. Due to the varied characteristics of wastes from different sections of the plant, a careful pilot plant study is essential. Segregation of different waste streams is a preliminary step in the treatment. Acidic wastes are neutralized with lime. Odor producing wastes are chlorinated. Cyanide bearing effluents are subjected to alkaline chlorination. Secondary treatments include biological oxidation with acclimatized microorganisms.

### **5.8.1 Food Processing Industry (Breweries, wineries waste)**

The food manufacturing wastewater contains high concentrations of several organic compounds including carbohydrates, starches, proteins, vitamins, pectines and sugars which are accountable for high COD and suspended solids.

Compared to other industries sectors, the food industry uses much greater volume of water for each ton of product. Wastewater generated from food manufacture has distinct characteristics that distinguish it from common municipal wastewater as it is biodegradable and nontoxic. Food wastewater is widely known for its high concentration of BOD and suspended solid. The constituent of food and wastewater are often complex to predict due to differences in BOD and pH in effluents from vegetable, fruit, milk and meat products and due to the seasonal nature of food processing and post harvesting.

In food processing plants, water use starts with conditioning raw materials such as soaking, leaning, blanching and chilling. It continues with cooling, sanitizing, steam generation for sterilization, power and process heating and finally direct in process use. The water

classification categories used in the food and beverage industry are general purpose, process, cooling and boiler feed.

While breweries and wineries produced beer and wine respectively as large number of products are obtained in distilleries. The range of products from distilleries includes industrial alcohols, rectified spirit absolute alcohol, Silent spirit, beverage alcohol etc. But two things are common in all the products mentioned above.

1. All the above products are obtained through the biochemical process of fermentation by yeast using carbohydrates as raw materials and
2. All the products contain ethyl alcohol in different proportions

In all the industries mentioned above are all characteristically of high BOD and they present a threat to the environment when discharge in to the water sources or to the land without treatment. Due to their varying potential pollution all the three industries will be discussed separately.

### **Manufacture of Beer**

Making of beer essentially consists of two stages

1. Preparation of malt from grains like barley.
2. Brewing the barley.

In the malt making the barley grain are steeped (soaked) to bleach out color and then made to sprout under aerobic conditions. The grain malt is then dried and stored after screening the sprouts out.

The malt from the malt house is then transported to the brewing section, where the wort, the medium for fermentation is prepared by mixing the coarse grain malt with hot water and by transforming the starch to sugars boiling in hops. The wort is then inoculated with a prepared suspension of yeast which common the sugar to alcohol. When the fermentation is complete, the yeast and mall residue is filtered out and finally the beer is carbonated before packing for sale.

As the flavor of the product is of prime importance selection of raw materials & control of process is done accordingly.

### **Origin and characteristics of Breweries wastes**

Brewery wastes originate during preparation of the malt as well as brewing the barley. The spent water from the steeping process of the mall house is one source. This waste includes the water soluble substances of the grain that are diffused into it. Characteristically it contains a large amount of organic soluble solids indicated by a high BOD in the order of 400-800mg/lit and low suspended solids concentration. In the brewing plant, the major pollutant is the fermentation residue or the spent grains. This contains high suspended solids and also a high BOD. Wastes also originate in the preparation of yeast suspension (i.e Pre fermentation section) from washing of containers, equipments& floors and in the process of by product recovery from the spent grains. Large volume of almost unpolluted water also comes up as waste cooling water. While the molt house waste is usually alkaline in nature, the brewing plant is generally acidic.

### **Manufacture, origin and characteristics of wineries wastes**

The wineries utilize the fruit juices as the raw materials. So the first operation in any winery is the pressing of fermentable juice from the fruits like grape. The waste from this operation resembles that from the canning industry and includes the spent fruits or Pomace, wastage of fermentable juice and floor wash wastes etc. The second stage in any winery consists of fermentation of this juice employing the method describes earlier. The wine attains its final form at this stage and requires only blending and bottling for sale. The waste from this stage comes from fermenting, spillages, floor washing etc & resembles that from a brewery. In the third stage i.e the brandy plant, wine of either type or the fermentation residue in the wine making is distilled to obtain brandy. Depending upon the source of the brandy, the waste may have low to very high solid concentration and resembles distillery waste very much.

### **Effects on receiving streams/ sewers**

All the above types of wastes discussed earlier are not toxic to the aquatic life of the receiving stream. But due to their high BOD content, they depict the DO of the receiving water. These results in anaerobic decomposition of this organic solid, both settled & suspended, producing a malodorous condition over the fairly long stretch of the stream. The conditions further deteriorate due to the growth of sewage fungi. The dark color of the stream renders it unaesthetic.

Brewery waste, which is comparatively of lesser strength, may be discharged in a fresh condition into the sewers to the extent of 3-5 % of the domestic sewage. The strong acidic or putrefied brewery waste will disrupt the normal biological activities of the waste treatment plants. For the sake of safe the brewery waste, if discharged into the sewers must be screened & pre treated by lime. The very high BOD content of the distilled waste makes it non amenable to the aerobic biological treatment and as such it cannot be discharged into municipal sewerage system directly.

Brewery wastes being comparatively less strong can be treated by aerobic biological treatment, after screening and neutralization. Usually, the biological treatment is accomplished by two stage process for 90-94% BOD reduction. A flow sheet of one such brewery waste treatment plant employing high rate trickling filters is shown in fig. When sufficient land is available, the brewery waste may be used for broad irrigation after neutralization to utilize the fertilizing components of the waste.

The yeast sludge from distilleries which contains very high suspended solids & BOD & is rich in proteins, carbohydrates, vitamins may be treated separately for by product recovery. But in practice they are mixed & discharged along with the spent wash. Both closed anaerobic digestion & open anaerobic lagoon has been tried in India. A single stage digester is usually adopted for anaerobic treatment when land available is limited.

### **By product recovery**

The yeast sludge from the distilleries contains the degradation product of the dead yeast organic debris from the malts like proteins, fats, vitamins & carbohydrates. On the other hand the spent wash contains all the above nutrients unfermented sugars, amino acids, caramels, ammonium phosphate etc. here 2 types of byproduct. i.e., Nutrient rich animal feed & the potassium rich fertilizers may be recovered in distillery.

The segregation of yeast sludge for processing the animal feed is practiced in some distilleries which in turn reduces the insoluble BOD load of the waste.

Yeast powder of pharmaceutical grade can also be obtained from yeast sludge & spent wash mix, while the animal feed derived from the debris waste and from the spent wash of distillers is usually considered as useful cattle feed. Care should be taken in the use of animal feed derived from the spent wash of the molasses distilleries. The latter contains a large no of inorganic substances and produce a laxative effect on the cattle's. The repeated soaking of the liquid waste & drying under direct sunlight produces a very good feed for fish.

Whatever may be the desired by product, the liquid waste is first screened, evaporated & then dried distillery waste. The evaporating & concentration of soluble wastes is accomplished in different types of evaporates. The concentrated waste is then dried on conventional spray & drum driers. This product is known as dried distillery soluble (DDS) which is normally used as an animal feed. The DDS can further be incinerated in health (at temp not exceeding 700<sup>0</sup>C) to produce in organic ash rich in potassium salts can be further be purified by sequence of operations like leaching, filtration, & acidifying by sulphuric acid. It is further concentrated in vacuum evaporates and finally crystallization of KCL and sulphates is done. It may be noted that, the condensing water arising out of the process of evaporation of spent wash still contains a high BOD & should be treated before its disposal.

### 5.9 Recommended Questions

1. Explain the manufacturing process of the following industry with neat flow chart. Also mention the effect of effluent when discharged into the stream/sewer.
  - a. cotton and textile industry,
  - b. tanning industry,
  - c. cane sugar and distilleries,
  - d. dairy industry,
  - e. steel and cement industry
  - f. paper and pulp industry

### 5.10 Outcomes

1. Identify waste streams and design the industrial waste water treatment plant.
2. Manage sewage and industrial effluent issues.

### 5.11 Further Reading

1. <https://www.ecologixsystems.com/industry-dairy.php>
2. <http://textofvideo.nptel.ac.in/105106119/lec36.pdf>
3. <https://nptel.ac.in/courses/116104045/lecture1.pdf>
4. <https://nptel.ac.in/courses/103107088/module35/lecture1/lecture1.pdf>
5. <https://nptel.ac.in/courses/103107082/module5/lecture1/lecture1.pdf>